

HUMAN DESIGN
VENUS RETURN
REPORT





CONTENTS

Your Human Design Venus Return	4
Your Venus Return Chart	7
Summary of Venus Return Activations & Themes	9
Introduction - The Cycle Cross	10
Cycle Cross: The Right Angle Cross of The Vessel of Love 1	10
Cycle Profile Introduction	13
Cycle Profile Theme - 2/4 Profile	13
Introduction - Your Venus Return Nodal Environments	14
Conscious Nodal Environment: SN Gate 40 / NN Gate 37	14
Conscious Nodal Line Theme: Fourth Line Venus Nodes	16
Unconscious Nodal Environment: SN Gate 40 / NN Gate 37	17
Unconscious Nodal Line Theme: Sixth Line Venus Nodes	19
Overview of Venus Return Center Themes	21
Venus cycle Theme: Sacral Center Impacted	21
Venus cycle Theme: Ajna Center Impacted	21
Venus Cycle Center Themes: Defined Sacral Center	22
Venus Cycle Center Themes: Ajna Center	25
Overview of the Venus Return Channel Themes	28
Personal Channels	31
Activations of Channel 0108: Inspiration	32
Activations of Channel 2551: Initiation	40
Activations of Channel 3041: Recognition	55
Activations of Channel 1949: Synthesis	62



CONTENTS

Educational Channels	67
Activations of Channel 1762: Acceptance	68
Activations of Channel 0515: Rhythm	73
Introduction to Environmental Gates	78
Environmental Gates by: Head Center	79
Environmental Gates by: Ajna Center	81
Environmental Gates by: Throat Center	82
Environmental Gates by: G Center	83
Environmental Gates by: Heart Center	85
Environmental Gates by: Splenic Center	89
Environmental Gates by: Sacral Center	90
Environmental Gates by: Solar Plexus Center	91
Environmental Gates by: Root Center	99
The Not-Self: Your Undefined Centers	103
Venus Cycle Center Theme: Undefined Splenic Center	103
Venus Cycle Center Theme: Undefined Head Center	105
Conclusion	107



Your Human Design Venus Return

The Venus Return in Human Design marks a significant cycle of self-reflection, relationships, and values that occurs approximately every 225 days. This return invites you to examine how you connect with others, what you value most deeply, and how you express love, harmony, and beauty in your life.

Venus represents themes of relationships, worth, and alignment with your core values, making this return an opportunity to realign with what truly matters to you.

During the Venus Return, the energy of Venus can influence how gates, channels, and centers in your Human Design chart express themselves, shifting your focus toward relationships—both with others and yourself. It may highlight areas where you are out of alignment in your connections and where you can establish greater harmony and authenticity. Many experience this as a period of re-evaluating their priorities, cultivating self-worth, and deepening their capacity for meaningful relationships.

Rather than viewing the Venus Return as a time of challenge, it can be embraced as a moment of recalibration—a chance to live in greater alignment with your values and express the love and beauty that is within you.

Key Themes of the Venus Return

To navigate the Venus Return effectively, key themes to explore include:

- Reassessing your relationships and how they align with your values
- Deepening your sense of self-worth and connection to your authentic self
- Exploring what brings you joy, beauty, and harmony in life
- Aligning your emotional connections with your Strategy and Inner Authority

The Venus Return invites you to step back and reflect on how your relationships—whether romantic, platonic, or self-reflective—are serving your highest good. It's not about forcing change but about reconnecting with the authentic, loving energy that Venus represents in your chart.

Venus in Your Human Design Chart

In Human Design, Venus represents your values, your sense of beauty, and the harmony you seek in relationships. It also reflects the wisdom you carry about love and connection. With each Venus Return, you are invited to refine how you express these Venusian qualities and align them with your design.

This means:

- **Your Type's Strategy** remains your guide for navigating relationship dynamics during this cycle.
- **Your Inner Authority** is your compass for making decisions about relationships and values.
- The Venus Return doesn't change your core design but instead provides new energetic conditions to explore love and connection.

By staying true to your Strategy and Inner Authority, you can use the energy of the Venus Return to build deeper, more authentic relationships and create a life that reflects your values and desires.



Embracing the Gift of Your Venus Return

The Venus Return is a powerful opportunity to realign with love, harmony, and self-worth. It invites you to examine your relationships, your values, and the beauty you bring into the world. By staying true to your Strategy and Inner Authority, you can navigate this cycle with confidence, creating deeper connections and a life that reflects your most authentic self.

This is your chance to embrace the love and beauty within you, nurture yourself and your relationships, and live in alignment with your values. Use this period to reflect, realign, and create meaningful connections.

Lunar Influence for All Types

While the Lunar Return holds special significance for Reflectors, it also impacts all Types by influencing emotional patterns and instincts. For those with defined Authority, the Lunar Return can amplify or highlight certain emotional themes, offering an opportunity to reflect on how these patterns align with your design.

This means:

- **Your Type's Strategy** remains your primary guide for navigating the emotional and energetic themes of the Lunar Return.
- **Your Inner Authority** continues to serve as your compass as you reflect on the Moon's influence.

The Lunar Return provides a moment to pause, observe, and recalibrate, helping you realign with your authentic self.

By staying grounded in your Strategy and Inner Authority, you can work with the Moon's energy to support your growth and alignment.

Embracing the Gift of Your Lunar Return

The Lunar Return is a powerful opportunity to reconnect with your inner world, reflect on your emotional patterns, and realign with your authentic self. It invites you to honor the natural rhythms of life, using each monthly cycle as a chance to reset and grow. For Reflectors, it's a time to gain clarity and assess alignment with their environment, while for all Types, it offers a moment of introspection and recalibration.

By staying true to your Strategy and Inner Authority, you can navigate the Lunar Return with awareness and confidence, using the Moon's energy as a guide to live in greater harmony with your design. This is your chance to embrace the flow of life, honor your instincts, and move through each new cycle with clarity and purpose.



The Nature of Cycles

Astrological cycles don't "end" in an absolute sense. When one cycle transitions into another, the earlier cycle shifts into the background while its effects and lessons continue to influence you.

For example:

1st Saturn Return (Around Age 29-30):

- The 1st Saturn Return marks a major turning point, signalling the end of the first Saturn cycle and the beginning of a new phase of maturity.
- After this, Saturn's influence doesn't disappear—it integrates into your life. It becomes part of your foundation and continues to work in the background as you build on the lessons learned during the first cycle.
- However, its *active* influence fades as other cycles (e.g., Uranus Opposition, Chiron Return) take precedence.

2nd Saturn Return (Around Age 58-60):

- The 2nd Saturn Return brings Saturn to the foreground again, revisiting the themes of responsibility, discipline, and life structure.
- While the 2nd Saturn Return is a distinct phase, it builds on the lessons of the 1st Saturn cycle, which has been simmering in the background for decades.
- After the 2nd Saturn Return, Saturn's influence again recedes into the background but continues to shape long-term patterns.

What About Other Cycles, Like Uranus, Chiron, Lunar, Mars, Venus?

The same principle applies:

- **Uranus:** Uranus Opposition (around age 40-42) doesn't mean Uranus disappears after that point. Its themes of freedom and individuality remain, but they shift into the background as other cycles (like Chiron) take precedence. Uranus comes to full completion at the Uranus Return (around age 84).
- **Chiron:** Chiron's influence begins to peak at the Chiron Return (around age 50) and continues in the foreground for many years, but it doesn't "end" until well into old age—for those who live long enough.

Interlocking Cycles

So, cycles don't "end" in an absolute sense—they overlap and interlock:

- Earlier cycles (like the 1st Saturn cycle) become part of the thematic foundation of your life.
- Subsequent cycles (like Uranus and Chiron) take the foreground, but Saturn's influence remains present in the background.
- These cycles are cumulative and layered—each one builds on the last, creating a lifelong interplay of energies.

Final Thought:

Think of these cycles like a symphony:

- Saturn might play the dominant melody early on, but as Uranus, Chiron, and other planetary cycles join in, Saturn's melody fades into the background. It's still there, harmonizing with the other instruments, but it's no longer the dominant sound.



Your Venus Return Chart

Birth Details: Lee Evans, 25/02/1964, 12:00:00, Avonmouth, United Kingdom
Venus Return: 20/03/2026, 08:54:50

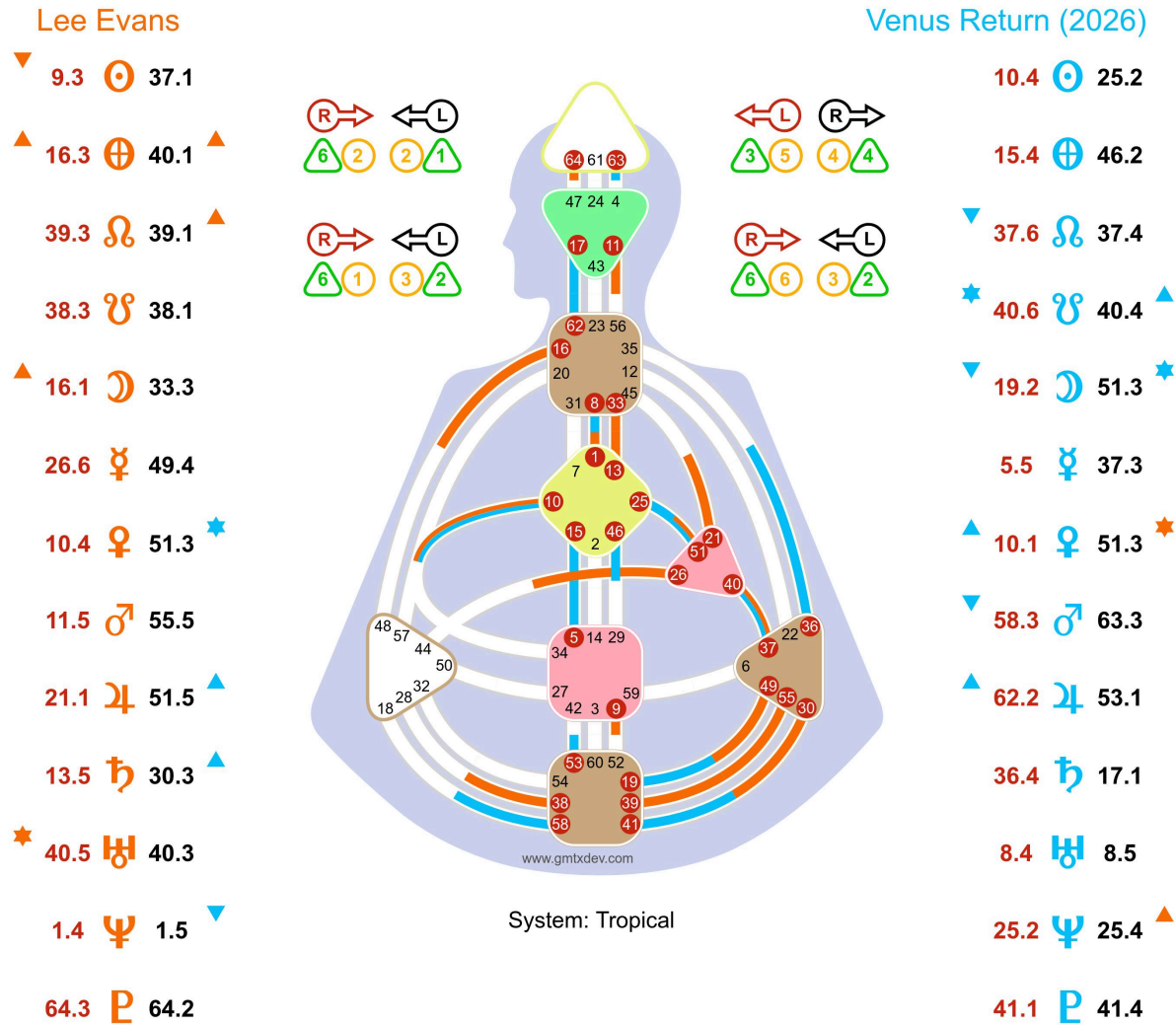

WELCOME

Lee, the chart displayed is your Quantum Venus Return. In the left-hand column below your name are the unconscious (Design) and conscious (Personality) Gates, Lines, and Planets. To the right are the Venus Return details. Your Foundation Chart details appear to the right of this welcome message, serving as a reminder to always follow your Inner Authority and Strategy.

FOUNDATION CHART

Type	Projector
Profile	1/3 - Investigating / Martyr
Strategy	Wait for Invitation
Authority	Solar Plexus



PRINT THIS PAGE

- Lee Evans
- ▼ 9.3 ♀ 37.1
 - ▲ 16.3 ⊕ 40.1
 - 39.3 ♀ 39.1
 - 38.3 ♀ 38.1
 - ▲ 16.1 ☾ 33.3
 - 26.6 ♀ 49.4
 - 10.4 ♀ 51.3 ★
 - 11.5 ♂ 55.5
 - 21.1 ♃ 51.5 ▲
 - 13.5 ♃ 30.3 ▲
 - ★ 40.5 ♃ 40.3
 - 1.4 ♀ 1.5 ▼
 - 64.3 ♀ 64.2

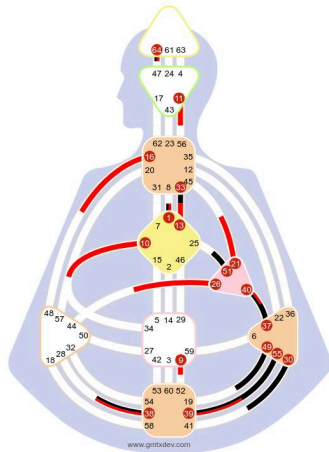

Definition:
Single

Personal Channels
Inspiration (1-8)
Initiation (25-51)
Recognition (30-41)
Synthesis (19-49)

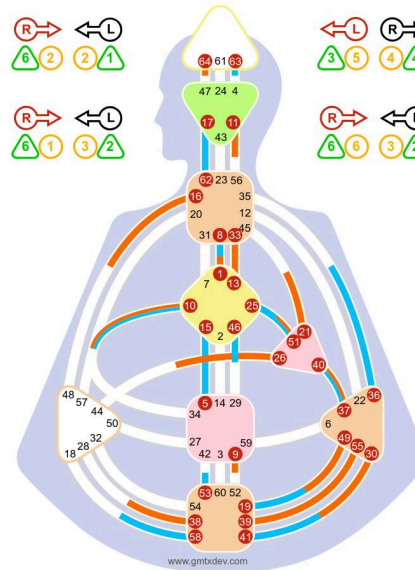

System: Tropical

Connection Channels

Educational Channels
Acceptance (17-62)
Rhythm (5-15)

- Venus Return (2026)
- Pe-Exp 10.4 ♀ 25.2 Pe-Exp
 - Pe-Exp 15.4 ⊕ 46.2 Pe-Exp
 - Env ▼ 37.6 ♀ 37.4 Env
 - Env ★ 40.6 ♀ 40.4 Env
 - Pe-Pn ▼ 19.2 ☾ 51.3 ★ Ed-Pn
 - Ed-Pn 5.5 ♀ 37.3 Env
 - Env ▲ 10.1 ♀ 51.3 ★ Ed-Pn
 - Env ▼ 58.3 ♂ 63.3 Env
 - Ed-Dev ▲ 62.2 ♃ 53.1 Env
 - Env 36.4 ♃ 17.1 Ed-Dev
 - Pe-Dev 8.4 ♃ 8.5 Pe-Dev
 - Pe-Dev 25.2 ♀ 25.4 ▲ Pe-Dev
 - Pe-Dev 41.1 ♀ 41.4 Pe-Dev

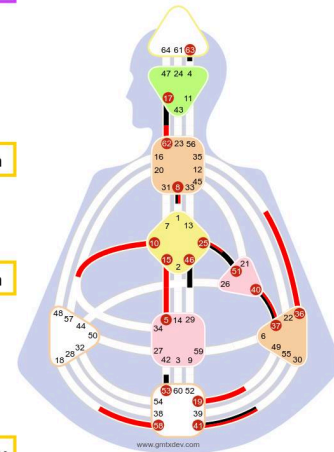

Predictor Keys

Ed-Dev	Educational Developmental
Ed-Dir	Educational Directional
Ed-Pn	Educational Person
Env	Environmental
Pe-Dev	Personal Developmental
Pe-Dir	Personal Directional
Pe-Pn	Personal Person
Pe-Exp	Personal Experimental



Summary of Venus Return Activations & Themes

Planets		Gate	Line	Theme
Sun: Radiance	P	25 - Innocence	2 - The Existentialist	Experiential
	D	10 - Treading	4 - The Opportunist	Experiential
Earth: Grounding	P	46 - Pushing Upwards	2 - The Prima Donna	Environmental
	D	15 - Modesty	4 - The Wallflower	Environmental
Moon: Focus	P	51 - The Arousing	3 - Adaptation	Person
	D	19 - Approach	2 - Service	Person
True Node: Future Direction	P	37 - The Family	4 - Leadership by Example	Environmental
	D	37 - The Family	6 - Purpose	Environmental
Mean Node: Past Direction	P	40 - Deliverance	4 - Organisation	Environmental
	D	40 - Deliverance	6 - Decapitation	Environmental
Mercury: Communication	P	37 - The Family	3 - Evenhandedness	Environmental
	D	5 - Waiting	5 - Joy	Environmental
Venus: Values	P	51 - The Arousing	3 - Adaptation	Person
	D	10 - Treading	1 - Modesty	Person
Mars: Maturing Energy	P	63 - After Completion	3 - Continuance	Environmental
	D	58 - The Joyous	3 - Electricity	Environmental
Jupiter: Law and Protection	P	53 - Development	1 - Accumulation	Environmental
	D	62 - Preponderance Of The Small	2 - Restraint	Environmental
Saturn: Rules and Discipline	P	17 - Following	1 - Openness	Developmental
	D	36 - The Darkening Of The Light	4 - Espionage	Developmental
Uranus: Unusualness	P	8 - Holding Together	5 - Dharma	Developmental
	D	8 - Holding Together	4 - Respect	Developmental
Neptune: Distraction	P	25 - Innocence	4 - Survival	Developmental
	D	25 - Innocence	2 - The Existentialist	Developmental
Pluto: Truth	P	41 - Decrease	4 - Correction	Developmental
	D	41 - Decrease	1 - Reasonableness	Developmental
P = Personality. This is classified as the conscious side.				
D = Design. This is classified as the unconscious side.				



Introduction - The Cycle Cross

Your Cycle Incarnation Cross represents the themes you are here to learn and understand during this period. It highlights the energies influencing your experiences and serves as a blueprint to deepen the impact of your Foundation Incarnation Cross throughout this cycle.

By exploring your Cycle Cross—determined by the positions of the cycle’s conscious and unconscious Sun and Earth—you can uncover the themes and patterns shaping your journey during this time. This understanding provides valuable insights into the core energies, potential challenges, and the lessons you are here to embody in this cycle.

Recognizing and embodying your Cycle Cross can help you identify the obstacles you may encounter, the strengths you can leverage, and how these energies interact with your Foundation Incarnation Cross. This awareness empowers you to navigate life with greater clarity and purpose, aligning your actions with the themes and growth opportunities unique to this cycle.

Cycle Cross: The Right Angle Cross of The Vessel of Love 1

During this cycle, you experience the energies of the Vessel of Love, a powerful combination of forces that shape your journey and interactions with the world. This cycle brings together all four gates of love, offering a unique and transformative expression of love, behavior, and human connection. The energies of this cycle invite you to embody love in its purest form, express it authentically, and share it with the world.

Geometry: Right Angle

Having a Right Angle Incarnation Cross in this cycle means your journey is deeply personal, emphasizing self-exploration and individual experiences. The theme of this cycle revolves around personal growth and self-discovery, guiding you toward a deeper understanding of yourself. This path encourages you to explore your unique talents, desires, and challenges, helping you cultivate a strong sense of identity and purpose.

By focusing on internal growth, you shape your understanding of the world and your place within it, fostering a profound connection with your true self. While your journey centers on personal fulfillment, it naturally influences others. As you pursue your unique path, your authenticity and determination become a source of inspiration to those around you.

By staying true to your path, you embody the power of living in alignment with your true nature. This authenticity not only strengthens your personal journey but also inspires others to embark on their own paths of self-discovery. In this way, your personal growth becomes a catalyst for positive change in the lives you touch during this cycle.

Interactions with Your Foundation Cross

If your Foundation Cross is Left Angle (and thus transpersonal): This cycle deepens your understanding of transpersonal themes, offering opportunities to refine and expand your role within the collective.

If your Foundation Cross is Right Angle (and thus personal destiny): This cycle opens you to new transpersonal possibilities, encouraging you to explore how your personal journey intersects with the collective experience.

If your Foundation Cross is Juxtaposed (and thus fixed fate): This cycle introduces you to the essence of transpersonal geometry, allowing you to experience a broader connection to the collective for the duration of this cycle.



Quarter: Initiation (Theme of Mind)

In the Quarter of Initiation, this cycle centers on the mind and the transformative power of education. This phase emphasizes intellectual growth, the pursuit of knowledge, and the ability to inspire others through the exchange of ideas. It invites you to explore new concepts, expand your understanding, and engage in continuous learning with curiosity and openness.

During this cycle, your journey is one of mental exploration—pushing the boundaries of understanding and fostering innovation. By embracing the themes of this quarter, you align with its purpose: to develop a deeper comprehension of the world, your role within it, and the valuable insights you can contribute.

This quarter encourages you to cultivate a mindset of curiosity, share your discoveries, and inspire meaningful dialogue. Your dedication to learning and sharing knowledge not only enriches your own life but also serves as a beacon for those around you, fostering growth and enlightenment within your community.

Cycle Conscious Sun in Gate 25: (The Gate of Innocence)

During this cycle, Gate 25 represents the essence or contents of the Vessel of Love. This energy embodies universal, unconditional love that flows within and through you. It supports a natural awareness of the pure and innocent nature of love, allowing you to approach life and relationships with an open heart. This cycle highlights the importance of returning to the essence of love, grounding your conscious experience in the nourishing and sustaining power of unconditional love.

Personality Earth in Gate 46 (The Gate of Determination):

Your Personality Earth in Gate 46 represents the inner wall or flesh of the Vessel of Love. This position offers you opportunities to ground yourself in the physical world and manifest love through determination and bodily wisdom. Here, you can explore the balance between love and physical expression, pushing through challenges with a love-driven determination. This placement invites you to embrace the physical aspects of love, providing a foundation for your conscious expression of universal love. As the inner wall, you have the conscious capacity to give form and substance to love, containing and sustaining it within yourself.

Cycle Unconscious Sun in Gate 10: (The Gate of Behavior of the Self)

This cycle brings the energy of Gate 10 into focus as the lip of the Vessel of Love, where love is expressed and poured out into the world. This energy supports an unconscious understanding of authentic behavior and self-love, offering a natural grace in navigating relationships and social situations. It fosters an instinctive ability to express love in ways that are appropriate and beneficial, channeling the essence of love into actions that inspire and uplift.

Cycle Unconscious Earth in Gate 15: (The Gate of Extremes)

Gate 15 represents the outer wall or aura of the Vessel of Love, where love interfaces with the world. This energy brings an unconscious ability to embrace humanity's diversity and balance extremes. It supports adaptability, rhythm, and a magnetic presence that naturally attracts and connects with others. This cycle highlights the importance of grounding yourself in love for humanity and using your unconscious influence to foster harmony and collective well-being.

Integration of the Cycle Cross

As a whole, the Vessel of Love 1 in this cycle offers an opportunity to embody love in its totality. The essence of universal, unconditional love is brought into your conscious awareness, while the physical manifestation of this love is grounded in determination and bodily wisdom. Unconsciously, the cycle supports authentic behavioral expression as the means of sharing love and a magnetic presence that radiates love to the world.

The journey of this cycle involves integrating the different aspects of the Vessel of Love. You



consciously embody the pure essence of love and its physical determination while unconsciously expressing love through authentic behavior and creating a magnetic aura that embraces diversity. Together, these energies create a complete and functioning Vessel of Love, capable of inspiring transformation and connection.

This cycle invites you to explore the balance between the conscious and unconscious aspects of love. By integrating your awareness of universal love with the instinctive ability to express and radiate it, you can become a powerful force for positive change. Your unique configuration allows you to channel love in a way that nourishes both yourself and others, embodying the true essence of the Vessel of Love.

This cycle is not just about experiencing love in its various forms—it is a living expression of love in action. You are invited to embody the Vessel of Love fully, using its energies to inspire and transform those around you. By balancing and expressing the different aspects of the vessel, you can create a ripple effect of love that positively impacts the world.



Cycle Profile Introduction

The cycle profile is determined by the Sun and Earth positions of your Venus Return. This profile establishes the foundation for the cycle's incarnation cross, representing the themes you are designed to embody and explore during this transformative period.

It's important to note that this cycle profile does not replace your foundational profile. Instead, it introduces an experiential layer of themes that your core profile is designed to engage with, learn from, and evolve through during the Venus Return. This is a time of deep growth and alignment, as you integrate these new themes into your journey.

Cycle Profile Theme - 2/4 Profile

In this cycle, you are designed to embody and learn about the 2/4 Profile, blending the reclusive nature of the Hermit with the social ease of the Opportunist. The 2nd Line reflects a need for solitude, where you will naturally uncover and develop your inherent talents. These abilities can often be so natural that you may not fully recognize their value. However, the world around you will notice and call you out, inviting you to share your gifts.

The 4th Line, on the other hand, represents a natural ability to build and nurture relationships. It is gifted at creating trust and forming connections, and through these bonds, opportunities often flow into your life. While the 2nd Line draws you inward, the 4th Line pulls you outward, creating a push-and-pull dynamic in this cycle theme. This may sometimes feel like a tension between wanting to retreat into your own space and being drawn into the world by others.

This cycle challenges you to learn about and balance these two aspects of this profile theme. Honoring a need for solitude is essential for the 2nd Line to develop its gifts but so is responding to the call of others who recognize and value your abilities. Your relationships and network serve as a bridge, creating opportunities for you to share your talents and make an impact in the world.

Ultimately, this cycle is about finding the balance between these two themes. By embracing both a need for personal space and an ability to connect with others, you can step into the fullness of this profile. The dynamic interplay between solitude and connection is what defines your unique path in this cycle, helping you fulfill your purpose in a way that feels authentic and aligned with your underlying Foundation Cross.



Introduction - Your Venus Return Nodal Environments

The Conscious and Unconscious Gates and Lines of the Venus Return South and North Nodes represent the overarching environmental themes that serve as a backdrop to your Venus Return cycle. These nodes, being oppositions, create a framework within which your Venus Return plays out. These nodes also bring a direction for the environment subtly emphasizing the South or North Node theme depending on how far you are into the cycle.

The environments shaped by the nodes condition the people around you, meaning you will observe these themes reflected in the behaviors and dynamics of those in your surroundings. The nodes represent a directional influence for the cycle, and these conscious and unconscious directions may become personal or educational for you, depending on the specifics of your Venus Return. Even if the nodes do not form directional channel themes, they still provide an environmental framework within which your Venus Return is conditioned to unfold.

Conscious Nodal Environment: SN Gate 40 / NN Gate 37

Your Venus Return cycle begins with a conscious awareness of the energy of the 40th Gate in Virgo, your Venus Return Conscious South Node. This cycle, the environment around you highlights themes of willpower, boundaries, and the balance between giving and receiving within relationships and communities. Gate 40, the Gate of Aloneness, resides in the Will Center and governs the use or withholding of energy in service to the group. The Virgo influence adds a sense of practicality, precision, and a focus on service, encouraging you to observe how people manage their willpower and contributions, as well as how they navigate exhaustion, denial, and fairness in communal efforts.

In the early part of the cycle, you may notice people around you grappling with questions of how much they can or should contribute to their relationships or communities. Some may struggle with overextending themselves in an effort to serve, while others withdraw their energy entirely, feeling unappreciated or undervalued. Gate 40 highlights the balance (or imbalance) between effort and reward, showing how willpower shapes the dynamics of belonging and support. The Virgo influence sharpens your focus on the practical aspects of these exchanges, helping you discern when loyalty and appreciation are authentic and when they are not.

This energy encourages self-reflection as well. You may find yourself assessing your own boundaries and contributions, questioning whether the energy you give is being met with the emotional support and loyalty you need. Gate 40 carries a lesson about sustainable giving—about using your willpower wisely rather than depleting yourself in service to others. The Virgo influence encourages you to take a grounded, analytical approach to this reflection, helping you find clarity about where your energy is best directed.

As the cycle progresses, the influence of the 37th Gate in Pisces, your Venus Return Conscious North Node, begins to emerge. This energy shifts your focus toward emotional connection, loyalty, and the bonds of community. Gate 37, the Gate of Friendship, resides in the Venus Plexus Center and governs the emotional waves that flow through relationships. The Piscean influence adds a sense of compassion, fluidity, and spiritual depth, encouraging you to observe how emotional needs are expressed, fulfilled, or denied within families, friendships, and social groups.

Gate 37 emphasizes the role of emotional awareness in creating and maintaining community bonds. You may notice people around you seeking connection through loyalty, appreciation, and emotional exchange. Some may openly express their needs for belonging and support, while others may struggle to voice these needs, fearing rejection or imbalance. The Piscean influence deepens your capacity for empathy and understanding, helping you see the emotional



undercurrents that drive group dynamics. This energy calls you to explore the emotional side of community life, learning how to navigate the waves of desire, appreciation, and negotiation that shape relationships.

Together, the 40th and 37th Gates form the Channel of Community, known as "A Design of a Part Seeking a Whole." This channel reflects the human drive to belong, balancing the practical contributions of willpower (Gate 40) with the emotional bonds of loyalty and friendship (Gate 37). The energy of this channel emphasizes the interplay between giving and receiving, showing how sustainable communities are built on a foundation of fair exchange and mutual support. This cycle, you are invited to reflect on the dynamics of connection, contribution, and loyalty in your relationships, learning how these forces work together to create harmony and belonging.

In the early part of the cycle, the energy of Gate 40 sets the tone, creating an environment where practical concerns dominate. You may notice people focusing on their responsibilities, negotiating their capacity to give, or withdrawing their energy when they feel unappreciated. This energy highlights the importance of boundaries and discernment, showing how willpower can be used to strengthen community bonds or withheld to maintain balance. The Virgo influence adds a layer of precision and practicality to these observations, helping you see the underlying dynamics of effort and reward.

As the influence of Gate 37 grows stronger, the environment shifts toward emotional connection and the bonds of friendship. You may notice people seeking belonging, expressing their emotional needs, and negotiating loyalty within their relationships. This energy invites you to explore the emotional side of community life, understanding how appreciation and support create the foundation for trust and unity. The Piscean influence adds a sense of compassion and fluidity, encouraging you to approach these dynamics with empathy and an open heart.

The dynamics in relationships around you reflect this broader journey from willpower and boundaries to emotional connection and community. Early in the cycle, the energy of Gate 40 highlights the practical aspects of relationships, inviting you to observe how effort and reward are balanced (or imbalanced) in your interactions. You may notice others grappling with questions of contribution and value, reflecting on how much they are willing to give and what they expect in return. This energy encourages you to reflect on your own boundaries, helping you clarify where your energy is best directed.

As the cycle unfolds, the influence of Gate 37 shifts the focus toward the emotional side of relationships, highlighting the importance of loyalty, appreciation, and emotional exchange. You may notice others seeking deeper connections, negotiating their needs for belonging and support, or expressing their appreciation for the contributions of others. This energy invites you to explore the emotional patterns that shape your relationships, learning how to foster trust and harmony through emotional attunement and fair exchange.

By the end of the cycle, you will have gained a deeper understanding of how the interplay between willpower and emotional connection shapes the environment and relationships around you. The journey through the Channel of Community reveals how individuals seek to find their place within the whole, balancing their practical contributions with their emotional needs. Whether as an observer, a participant, or a guide, this cycle offers the opportunity to reflect on the dynamics of belonging and support, learning how to navigate the complexities of loyalty, effort, and exchange with greater awareness and wisdom.

Through this journey, you may uncover profound insights about your own role within communities. The energy of Gate 40 invites you to explore your boundaries and contributions, reflecting on how your willpower is used in service to the group. The energy of Gate 37 encourages you to deepen your emotional connections, learning how loyalty and appreciation create the bonds that hold



communities together. Together, these energies reveal the essential dynamics of human connection, showing how practical effort and emotional support must align to create sustainable, thriving communities.

This Venus Return cycle encourages you to embrace the themes of "A Part Seeking a Whole," recognizing how emotional bonds and willful action work together to create a sense of belonging. By observing and reflecting on these themes in your environment, you may develop a deeper understanding of the forces that sustain relationships and communities. Whether you are called to nurture emotional connections, apply your energy in service, or simply bear witness to the unfolding dynamics, this cycle provides an opportunity to refine your awareness and wisdom about the essential interplay of emotions and willpower in community life.

Conscious Nodal Line Theme: Fourth Line Venus Nodes

Your perspective on the Gate defined Venus Nodal Environments is further shaped by the lines imprinted as part of the Venus Environment gates.

In this Venus Return, your Conscious Nodal Environment is imprinted with Fourth Line themes, inviting you to attune to the energies of connection, influence, and opportunity through relationships. Fourth Lines are naturally attuned to building networks because all their potential flows through the bonds they create. In this cycle, you will consciously resonate with environments where trust, mutual support, and authentic relationships are key to fostering growth and influence. The Fourth Line is not scattered in its energy; it is highly focused and dedicated to its specific theme, as expressed through the gates of the nodes. This singular focus aligns with the energy of "brotherhood/sisterhood," creating a sense of belonging and shared vision that supports both individual and collective success. You may notice individuals around you who are deeply committed to cultivating opportunities within their networks, leveraging their connections with precision and intent to align with their goals.

The Fourth Line's behavioral archetype is "The Opportunist," reflecting its design to thrive through relationships. For the Fourth Line, everything in life is about who they know, as their potential only fully manifests through the proper network. In this cycle, you may notice individuals in your Venus environment who are natural networkers, consistently building and maintaining relationships to open doors of opportunity. However, this relational dedication comes with a duality—the Fourth Line's kindness and generosity are extended to those they trust and value, but they can quickly become cold, detached, or even resentful when trust is broken, or the environment feels unstable. Fatigue is another natural challenge for the Fourth Line, as constant availability to others—especially when it yields no opportunities—can leave them drained and frustrated. This kindness/meanness dynamic reveals how deeply the Fourth Line's energy is tied to the state of their relationships, oscillating between warmth and withdrawal depending on how supported and aligned they feel.

In terms of sharing, the Fourth Line is "The Magnanimous One." There is a grandness to their generosity, but it is not extended to everyone. Their magnanimity is reserved for their friends—the people they are closest to and trust most deeply. While the Fourth Line waits for opportunities to come through their network, the person who provides the opportunity is often overlooked in favor of giving back to their inner circle. Interestingly, this dynamic underscores the kindness/meanness duality; the Fourth Line can be extraordinarily giving and warm with their trusted allies, but distant or indifferent to those outside their inner circle. In this cycle, you may notice individuals who radiate warmth and generosity toward those they trust yet seem to redirect the advantages they've gained to their closest allies rather than those who directly supported them. These dynamics emphasize the importance of trust and alignment in the Fourth Line's sharing process.

In intimate settings, the Fourth Line is "The Companion," approaching intimacy through the



foundation of friendship. For the Fourth Line, true intimacy cannot exist without companionship, as they use friendship as a way to establish trust and assess the potential for deeper connections. This archetype is often marked by a certain sneakiness—"Would you like to be friends? I'll be your friend. I'll be the person you can talk to." Beneath this friendliness is a theme of voyeurism, as the Fourth Line observes and evaluates whether the connection is correct for greater intimacy. This kindness/meanness dynamic can also show up in intimacy—when trust is established, the Fourth Line brings warmth and loyalty, but without that foundation, they can withdraw and protect themselves from deeper connections. In this cycle, you may notice individuals who approach relationships with this energy of friendship first, waiting for the right moment to deepen the bond. The process of companionship is essential for the Fourth Line, as it ensures that deeper intimacy is aligned and mutually supportive.

In this cycle, your Venus Nodal Environment highlights the Fourth Line's dualities: kindness and meanness, warmth and withdrawal, generosity and fatigue. When aligned, the environment will feel like a space of trust, mutual respect, and harmonious relationships, fostering collaboration and the flow of opportunities for growth and expression. However, when unbalanced, the Fourth Line's energy can become cold or withdrawn, protecting itself from rejection or instability. You will notice individuals who embody the Fourth Line's energy by building strong networks and leveraging their relationships to create opportunities, while also navigating the challenges of relational fatigue and the need for reciprocation. These qualities confirm that you are in the right place and aligned with the right perspective relative to the themes of your Venus Nodal gates. By attuning to these dynamics, you align yourself with a Venus environment that values trust, loyalty, and the transformative power of authentic connection.

Unconscious Nodal Environment: SN Gate 40 / NN Gate 37

Your Venus Return cycle begins with an unconscious immersion in the energy of Gate 40 in Virgo, your Venus Return Design South Node. This cycle, the environment is shaped by themes of willpower, boundaries, and the balance between giving and receiving. Gate 40, also known as the Gate of Aloneness, resides in the Will Center and governs the use (and withholding) of energy in service to the community. For your body, it is an unconscious response to the environment, where the dynamics of effort, boundaries, and reciprocity naturally arise.

Gate 40 creates an environment where the balance between individual effort and group support becomes the focal point. The grounded and analytical energy of Virgo enhances this process, encouraging your body to align with the discernment and practicality required to manage energy effectively. Your body instinctively senses when to offer its energy in service and when to withhold it to conserve resources or maintain boundaries. In professional settings, it perceives how fair exchanges of effort and appreciation sustain collaboration. In personal relationships, it notices how imbalances in giving and receiving can either strengthen or weaken connections. Your body unconsciously aligns with this energy, navigating the dynamics of contribution and reciprocity with precision and care.

In this environment, your body observes how individuals manage their willpower in response to loyalty and appreciation. It senses how some overextend themselves in an effort to serve, while others withhold their energy due to perceived imbalances or unmet emotional needs. The energy of Gate 40 highlights the importance of setting boundaries and using willpower wisely to sustain healthy relationships and communities. Your body instinctively supports this process, amplifying the potential for harmony and mutual respect in the spaces it inhabits.

Challenges in this environment may arise for those who resist the energy of Gate 40. Some may struggle to establish boundaries, overcommitting themselves to meet others' needs, while others may withhold their energy out of mistrust or resentment. Your body unconsciously perceives these struggles, sensing the tension created when willpower is misapplied or imbalanced. This



environment calls for discernment, asking you to trust your body's ability to navigate the balance of giving and receiving with wisdom and care.

As the cycle progresses, the energy of Gate 37 in Pisces, your Venus Return Design North Node, begins to take greater prominence. This does not replace the influence of Gate 40 but instead shifts the environment's focus toward themes of emotional needs, loyalty, and the dynamics of community. Gate 37, also known as the Gate of Friendship, resides in the Venus Plexus Center and governs the emotional waves that flow through relationships. For your body, it is an unconscious response to the environment, where emotional bonds and the instinctual drive for connection emerge naturally.

Gate 37 creates an environment where emotional needs and the desire for connection dominate. The compassionate and fluid energy of Pisces enhances this process, encouraging your body to unconsciously align with the emotional patterns and undercurrents that shape human relationships. Your body instinctively senses how emotional needs are expressed, fulfilled, or denied within families, friendships, and social groups. This is not about consciously analyzing these dynamics—it is about your body's natural ability to navigate emotional waves and attune to the bonds that hold communities together.

In this environment, your body observes how loyalty and appreciation are exchanged for practical contributions such as time, effort, or resources. It senses the subtle emotional contracts that underpin relationships, recognizing when these exchanges are balanced and when they are not. In professional settings, your body perceives how emotional attunement fosters teamwork and collaboration. In personal relationships, it notices how unspoken emotional needs can either strengthen or strain connections. Like a river flowing through a community, your body unconsciously aligns with the energy of Gate 37, amplifying the potential for harmony and unity in the spaces it inhabits.

Challenges in this environment may arise for those who resist the energy of Gate 37. Some may suppress their emotional needs, fearing rejection or vulnerability, while others may overextend themselves emotionally in an effort to secure loyalty and appreciation. Your body unconsciously perceives these struggles, sensing the tension created when emotional needs are ignored or imbalanced. This environment calls for emotional awareness, asking you to recognize the importance of expressing and honoring emotional needs to create trust and connection.

The interplay between Gate 40 in the South Node and Gate 37 in the North Node highlights the energy of the Channel of Community, also known as "A Design of a Part Seeking a Whole." This channel embodies the human drive to belong, reflecting the interplay between willpower (Gate 40) and emotional needs (Gate 37). It reveals how individuals seek connection and mutual support, balancing practical contributions with emotional bonds to create a sense of belonging and trust. Your body unconsciously participates in this dynamic, sensing how willpower and emotional attunement work together to sustain relationships and communities.

Early in the cycle, the energy of Gate 40 sets the tone, creating an environment where effort, boundaries, and reciprocity take center stage. Your body instinctively observes how people manage their energy, questioning how much they can or should give, and whether their contributions are being valued. The Virgo influence fosters a grounded and practical approach, helping your body align with the wisdom of using willpower to strengthen community bonds. This energy highlights the importance of fair exchange, showing how effort and boundaries must align to sustain healthy and thriving relationships.

As the influence of Gate 37 grows stronger, the environment shifts toward the emotional aspects of connection, loyalty, and community. Your body instinctively observes how people seek connection, express emotional needs, and offer loyalty in exchange for support. The Piscean



influence fosters compassion and empathy, helping your body align with the deeper emotional patterns that shape group dynamics. This energy reveals how emotional awareness fosters unity and trust, while unmet needs or unbalanced exchanges create tension within relationships and communities.

The relationships and interactions around you also reflect this progression. Early in the cycle, your body may unconsciously sense how others navigate the practical dynamics of contribution and reciprocity, observing whether they establish healthy boundaries or overextend themselves. As the cycle progresses, the influence of Gate 37 encourages deeper awareness of emotional needs and loyalty. Your body notices how individuals balance their emotional desires with their contributions, reflecting on how these dynamics strengthen or strain relationships. This energy invites you to observe how willpower and emotions work together to create sustainable and harmonious connections.

By the end of the cycle, the interplay between Gate 40 in Virgo and Gate 37 in Pisces will have shaped the shared environment and the unconscious role your body plays within it. The journey through the Channel of Community reflects the dynamic interplay of willpower and emotional needs, showing how effort, boundaries, loyalty, and appreciation align to create belonging and trust. This Venus Return cycle offers your body an opportunity to align more deeply with the flow of life, trusting its innate wisdom to navigate the balance of effort and emotions, boundaries and connection.

Through this process, your body unconsciously participates in the dynamics of Gate 40 and Gate 37, instinctively navigating the energy of "A Part Seeking a Whole" as it unfolds. The lessons of this cycle highlight your body's role in observing and responding to the flow of life, contributing its unique gifts to the shared experience of loyalty, willpower, and community.

Unconscious Nodal Line Theme: Sixth Line Venus Nodes

Your form's unconscious perspective on the Gate-defined Venus Nodal Environments is further influenced by the lines imprinted within the Venus Environment gates.

In this Venus Return, your Unconscious Nodal Environment is imprinted with Sixth Line themes, meaning your body instinctively resonates with the energy of the Role Model and the ongoing journey of wisdom, integrity, and self-awareness. In this cycle, your body is naturally drawn to environments where individuals are navigating the Sixth Line's life phases: trial and error (ages 0-30), detached observation (ages 30-50), and embodied wisdom (age 50+). Your body feels at ease in spaces where these dynamics are unfolding—where people are making mistakes and learning from them, stepping back to gain clarity, or stepping forward as guiding examples. These environments carry a palpable tension between idealism and realism, and your body instinctively recognizes the Sixth Line's process of balancing these energies in the journey toward becoming a role model.

Your body also aligns with the Sixth Line's duality as both Role Model and Hypocrite. In environments where the Sixth Line energy is present, you may notice individuals striving to embody integrity and live authentically, while others grapple with the pressure of living up to expectations. Your body instinctively resonates with spaces where this tension is active—where people are either learning to integrate their experiences and rise as sources of wisdom or struggling with misalignment and criticism. These dynamics are especially visible in earlier phases of life, where mistakes can lead to external blame or internal doubt. Your body feels secure in environments where the Sixth Line's energy of striving toward integrity is honored, even when individuals falter or stumble along the way.

The Sixth Line's leadership style offers another dynamic your body instinctively tunes into. The



Sixth Line leads not by taking center stage but by creating systems, empowering others, and fostering collaboration. Your body feels grounded in environments where this quiet, visionary leadership style is present—where individuals inspire through optimism and grounded practicality, creating sustainable spaces for everyone to thrive. However, your body also recognizes when this leadership becomes unbalanced, such as when individuals detach or become overly idealistic in the face of challenges. In this cycle, as you observe these dynamics, your body will naturally attune to spaces where quiet strength and discernment guide leadership, signaling alignment with the Sixth Line's themes.

The Sixth Line's approach to sharing is another quality your body instinctively resonates with. Your body feels aligned in environments where generosity is purposeful and selective, where individuals invest their time and energy in ways that reflect their values and ideals. These environments feel stable and intentional, as the Sixth Line is naturally discerning in its sharing, ensuring its resources are directed toward meaningful connections. However, your body may also notice when this energy becomes critical or distant—where individuals withhold support even from those who are deserving. These dynamics of selective generosity and grounded sharing confirm that your body is attuned to the Sixth Line's energy, balancing idealism with practicality in its connections.

In the realm of intimacy, your body resonates with the Sixth Line's journey toward ideal connection and alignment. Your body feels at ease in spaces where individuals are navigating this process—learning from early mistakes, withdrawing to reflect, or stepping into wisdom and alignment later in life. You may notice individuals yearning for the perfect connection, whether in relationships, careers, or commitments, or reflecting on earlier choices with a sense of detachment or clarity. These dynamics play out in the Sixth Line's phases: early trial and error, midlife observation, and later-life embodied wisdom. Your body instinctively recognizes these rhythms, feeling secure in environments where people are growing into the wisdom of accepting life's imperfections while maintaining their ideals. By observing these themes, you align with the purpose and perspective of your Venus Nodal Environment, attuning yourself to the Sixth Line's energy of growth, authenticity, and embodied wisdom.



Overview of Venus Return Center Themes

Venus cycle Theme: Sacral Center Impacted

Themes of Consistent Energy and Creativity Emerging in this Cycle

In this cycle, with the Sacral Center temporarily defined in your Venus cycle, you will notice access to a steady and renewable source of energy, fueling creativity, productivity, and a sense of momentum. Tasks or projects that once felt overwhelming now feel more manageable, as this conditioned energy provides a consistent drive that can help you accomplish and create with greater ease. You may feel a surge of vitality, making it easier to engage with life and take on opportunities that excite you. This is a powerful time to explore how it feels to work with consistent energy and allow it to support your creativity and productivity in fulfilling ways. The energy is here to help you experience what it's like to stay energized and engaged—so enjoy the flow it brings!

Venus cycle Theme: Ajna Center Impacted

Themes of Certainty in Thought Processes and Mental Perspective Emerging in this Cycle

In this Cycle, with the Ajna Center temporarily defined in your Venus cycle, you may experience a newfound sense of consistency in your thought processes. Whether logical, abstract, or individual, your thinking may feel more structured and reliable, giving you the confidence to analyze, form conclusions, and express your ideas with clarity. This temporary definition offers a unique opportunity to explore the power of consistent thought patterns, helping you gain insights, refine your mental focus, and engage with the world in a more intentional way. Enjoy this time of mental clarity and self-assuredness as you navigate the cycle ahead!

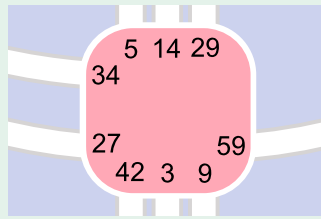

Venus Cycle Center Themes: Defined Sacral Center

The Mind and Its Illusion of Unlimited Energy

In your Foundation Design, you have an **undefined Sacral Center**, meaning your mind is naturally conditioned to push you beyond your limits, constantly questioning whether you're doing or achieving enough. The mind's strategy here is *"Never knowing when enough is enough."* This can create a tendency to overwork, overcommit, or stay in situations longer than is healthy, driven by the mental fear of not doing enough or letting others down.

In this **Venus Cycle**, however, your Sacral Center is **defined by cycle conditioning**, giving you temporary access to its consistent, sustainable energy. While this defined energy can feel empowering, it's important to remember that it's not your natural state.

Be cautious—this newfound energy is temporary. The shadow mind **will attempt** to take advantage of it, convincing you to push harder, commit to more, or ignore your natural limits. It will latch onto this defined energy as "proof" that you should always be capable of endless productivity. Because you now have temporary consistency in this center, your mind will also trick you into believing it suddenly knows "when enough is enough." This can lead to abrupt decisions—stopping tasks, projects, or even relationships prematurely—based on a false sense of finality or clarity.

The mind is so clever, yet so misguided. Its illusions often pull you away from your truth. However, your true power lies in observing this dynamic and allowing your **inner authority** to guide your decisions, rather than succumbing to the mind's conditioning. Resist the temptation to overdo, overextend, or cut things off abruptly. Remember that this defined energy is not permanent—it is only present during this cycle of conditioning. Trust your authority to discern when to engage and when to rest, when to continue, and when to let go—even if the mind insists otherwise.

Experiencing the Defined Sacral Center in the Venus Cycle

For this cycle, the defined Sacral Center offers you a taste of its consistent, sustainable energy. This can feel empowering, especially if you've previously struggled with energy limits or burnout. You may notice a natural rhythm of energy emerging, with the ability to work steadily on tasks that excite or fulfill you.

Use this time to explore how this defined energy feels compared to your usual state. Pay attention to your body's signals—does your gut response guide you into tasks that feel satisfying and aligned? Or does your mind try to override this natural energy with unnecessary busyness or obligations?

The defined Sacral Center is also linked to sexuality and creativity. You may experience a stronger connection to your sexual energy or feel inspired to channel this vitality into creative pursuits. However, it's crucial to honor your need for rest and recovery, even with this temporary boost of energy. Sustainable energy doesn't mean infinite energy. Observe how your energy flows during this period and use this awareness to inform how you manage your energy even after the Venus Cycle ends.



Key Characteristics of the Defined Sacral Center

- **Sustainable Energy:** A consistent, reliable source of life force energy for work, creation, and activity.
- **Responsive Nature:** Clarity and action come through responding to life with a gut instinct.
- **Sexual and Creative Energy:** A strong connection to sexuality, reproduction, and creative expression.
- **Impact on Others:** The ability to energize and motivate those around you.
- **Challenges:** Overcommitting or ignoring the need for rest and recovery.

Understanding the Defined Sacral Center

The Sacral Center is the powerhouse of the bodygraph—home to vital life force energy that sustains work, creativity, and sexuality. When the Sacral is defined, it provides a consistent and renewable source of energy. Only Generators and Manifesting Generators have a **naturally defined Sacral Center**, marking them as the energy builders and doers of society.

In this Venus Cycle, however, your Sacral Center is **temporarily defined through cycle conditioning**. This means you have access to a steady and sustainable energy flow during this period, but it is **not your natural state** and **not your inner authority**.

Sacral energy is most effectively utilized when it responds to life through the gut instinct. The Sacral response is visceral and nonverbal—an "**uh-huh**" (**yes**) feels like excitement, expansion, or a pull toward action, while an "**uh-uh**" (**no**) feels like resistance, contraction, or disinterest. However, because this energy is conditioned and not part of your innate design, it's essential to temper these responses with your **true inner authority**.

Ask yourself: *Does my inner authority want to use this temporary energy for my purposes?* If yes, then allow the defined Sacral to support you in aligned action. If no, trust your authority to guide you away from commitments or activities that are not correct for you, even if the Sacral energy feels powerful in the moment.

The Sacral Center and Its Role

The Sacral Center is deeply tied to sexuality and creativity. Those with a naturally defined Sacral often have a consistent connection to these energies, with a natural drive for sexual expression and the ability to channel this vitality into creative endeavors.

While Sacral energy is sustainable and regenerative, it is not infinite. Rest is essential to allow the body to recharge. Unlike undefined Sacral Centers, which can burn out quickly by amplifying the energy of others, defined Sacral beings naturally wake up each day with renewed energy for the tasks and activities that bring them joy.

During this Venus Cycle, you may feel energized and productive, but it's important to remember that this is **temporary conditioning**. Use this time to observe how the Sacral Center works and how it influences your energy levels and responses, but always let your true inner authority guide your decisions.

Sacral Energy and Its Impact on Others

Sacral energy also impacts those around you. People with undefined Sacral Centers may feel energized and motivated in your presence, but it's important to recognize that this energy is not meant to fuel others indefinitely. Likewise, because this energy is conditioned for you, it's not meant to be overused or relied upon as if it were your natural state. **So don't let others identify you as the "powerhouse" because this energy will go away at some point.** Learning to pace yourself and honor your natural rhythms ensures that your energy remains balanced and satisfying.



Closing Thoughts

The defined Sacral Center in your Venus Cycle offers you an incredible opportunity to experience its steady and sustainable energy. While this energy can feel empowering and productive, remember that it is temporary and conditioned. Observing how the Sacral Center functions during this period can help you understand the difference between responding to life with your gut and making decisions based on your **true inner authority**.

Trust your inner authority to guide you in deciding where to invest your energy. Resist the urge to overextend yourself just because the energy is available and avoid treating the Sacral Center as if it were your natural authority. By staying aligned with your design, you can make the most of this temporary definition, gaining valuable insights into your relationship with work, creativity, rest, and satisfaction.

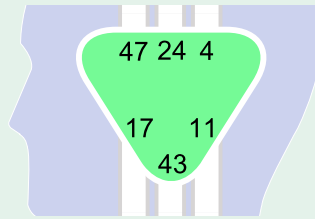

Venus Cycle Center Themes: Ajna Center

The Mind and Its Illusion of Certainty and Rigid Thinking

In your Foundation Design, you have an undefined Ajna Center, which means your mind is naturally conditioned to explore, question, and adapt to various perspectives. The shadow mind strategy of the undefined Ajna is "**pretending to be certain out of fear of intellectual embarrassment.**" This can create mental pressure to provide answers, form strong opinions, or appear confident in your conclusions, even when clarity is absent. The undefined Ajna thrives in openness, but when conditioned, it clings to the illusion of certainty, amplifies the ideas and opinions of others, and struggles to remain neutral in the face of uncertainty.

In this Venus Cycle, however, your Ajna Center is defined by cycle conditioning, giving you temporary access to a consistent and reliable mental framework. This defined Ajna energy provides a sense of intellectual certainty and stability, allowing you to form clear opinions, analyze concepts with confidence, and feel mentally grounded. While this can feel empowering compared to your usual state, it's important to recognize that this consistency is not your natural design.

Be cautious—this newfound mental clarity is temporary. Your mind may attempt to latch onto this sense of certainty, convincing you that you “know” or that your beliefs are absolute and unchanging. This can lead to rigidity in thinking, over-identification with opinions, and difficulty adapting to new perspectives, even when they are more aligned with your truth. The underlying **fear of being uncertain** can still arise, driving you to cling to ideas or conclusions to avoid discomfort. The tendency to justify or rationalize your thoughts may also increase during this time, creating unnecessary mental stress.

Your true power lies in observing these dynamics and allowing your inner authority to guide your decisions. Resist the temptation to rely solely on this conditioned mental framework or to overthink and intellectualize every situation. Remember, this defined energy is not permanent—it is only present during this cycle of conditioning. Trust your authority to help you navigate when to act on mental clarity and when to release attachment to ideas that no longer serve you.

Experiencing the Defined Ajna Center in the Venus Cycle

For this cycle, the defined Ajna Center offers you a taste of **consistent thought processes**. You may notice that your mind feels more structured and capable of thinking things through in a steady, reliable way. Depending on the specific definition, you might find yourself leaning toward a logical, abstract, or individual way of processing information. This consistency can feel empowering, especially for research, analysis, or working through complex ideas.

However, for someone with an **undefined Ajna**, this temporary definition can bring the illusion of mental certainty. You may suddenly feel confident in your opinions or conclusions, even defending them strongly, only to later find that they no longer resonate when the definition fades. This can lead to feelings of embarrassment or discomfort, especially if you've overcommitted to a particular perspective or belief that isn't truly yours.



The undefined Ajna naturally thrives in openness, with the ability to explore a variety of perspectives without needing to hold onto any one conclusion. During this Venus Cycle, however, the defined Ajna's consistent thought processes may make you feel as though you "know" something with certainty. While this can be a valuable experience, it's important to remain aware that this mental clarity is temporary and conditioned. It's not your natural state, and it's okay to let go of ideas or conclusions that no longer serve you when the definition fades.

This temporary consistency is a great opportunity to explore how a defined Ajna functions, but it's also a time to observe how you may over-identify with certainty or feel pressured to defend your thoughts. By staying aligned with your inner authority, you can navigate this period without getting stuck in ideas that might later feel limiting or out of alignment.

Key Characteristics of the Defined Ajna Center

- **Consistent Mental Framework:** A steady ability to process, analyze, and form conclusions.
- **Authority in Focused Areas:** Greater confidence in expressing ideas and opinions.
- **Capacity for Learning and Retention:** Enhanced ability to retain information and apply it effectively.
- **Mental Pressure:** A tendency to overthink or rationalize thoughts.
- **Challenges:** Rigidity in thinking and difficulty adapting to new perspectives.

Understanding the Defined Ajna Center

The Ajna Center is the center of mental activity, responsible for processing information, analyzing concepts, and forming beliefs. When defined, it provides a consistent and reliable mental framework, allowing for structured thinking and intellectual authority. However, this consistency can also lead to stubbornness, inflexibility, and over-identification with ideas.

In this Venus Cycle, your Ajna Center is temporarily defined through cycle conditioning. This gives you access to a stable mental framework during this period, but it is not your natural state and not your inner authority.

Defined Ajna energy operates with a sense of certainty, which can be both empowering and limiting. You may feel confident in your ideas and able to articulate them clearly, but this can also create a false sense of intellectual superiority or a reluctance to consider alternative viewpoints.

Ask yourself: Does my inner authority agree with this mental conclusion? If yes, allow the defined Ajna energy to support your clarity and confidence. If no, trust your authority to guide you away from rigid thinking or over-identification with temporary beliefs.

The Ajna Center and Its Role

The Ajna Center plays a key role in how we process thoughts, form beliefs, and conceptualize ideas. Those with a naturally defined Ajna have consistent access to structured mental clarity and often excel in areas requiring critical thinking, analysis, and problem-solving.

However, even those with a defined Ajna must remain open to adapting their beliefs and ideas over time. Intellectual certainty can create blind spots, leading to missed opportunities for growth and understanding.

During this Venus Cycle, you may feel more confident in your ability to analyze and articulate your thoughts. Use this time to observe how the defined Ajna functions and how it influences your mental processes. Let this experience teach you about the difference between acting on mental clarity and staying aligned with your true inner authority.



Ajna Energy and Its Impact on Others

The defined Ajna can influence those around you, especially those with an undefined Ajna Center. They may feel drawn to your mental clarity and confidence, but this is not a responsibility you need to take on. Likewise, because this energy is conditioned for you, it's not meant to be overused or relied upon as if it were your natural state.

Remember that this temporary energy is here to support your experience, not to create dependence in yourself or others. By staying aligned with your inner authority, you can use this defined energy to explore your mental processes without losing sight of your true self.

Closing Thoughts

The defined Ajna Center in your Venus Cycle offers you an opportunity to experience consistent mental clarity and analytical ability. While this energy can feel empowering, it is important to remember that it is temporary and conditioned. Observing how the Ajna Center functions during this period can help you understand the difference between mental certainty and true alignment with your inner authority.

Trust your authority to guide you in deciding which beliefs to hold onto and which to release. Resist the urge to over-identify with this temporary clarity or to cling to rigid thinking. By staying aligned with your design, you can make the most of this temporary definition, gaining valuable insights into your relationship with mental clarity, belief systems, and the evolving nature of knowledge.



Overview of the Venus Return Channel Themes

During this Venus cycle, you may notice the emergence of channels that are not present in your Foundation Design. These new channels are formed in two primary ways: through the interaction of Venus Return imprinting—where gates and lines combine to create complete Venus Return channels—and through the interaction between Venus Return imprinting and specific gates and lines with gates and lines in your Foundation Design.

The resulting channels represent significant energies and themes that will shape your experiences in the cycle. These channel themes, given the length of this cycle, are also likely to reoccur more than once. Whether or not you engage with these themes depends on the guidance of your Inner Authority. These channels fall into two categories: Educational or Personal in nature. Within these channel types, further nuances unfold, revealing whether they are developmental, directional, or triggered by a specific person you are destined to meet. Each channel offers a unique opportunity for growth and alignment throughout the Venus cycle.

Educational Channels

An Educational Channel is formed by two or more gates in your Venus Return Cycle. These gates are not part of your Foundation Design, making the channel educational in nature. The channel may also connect two undefined centers in your design, further amplifying the educational effect.

Educational Channels can be **Developmental**, **Directional**, or formed through interactions with **two or more people** that you meet. The specifics of the Educational Channels created in this cycle are discussed in greater detail later in this report.

Personal Channels

A Personal Channel is formed when one gate (which may include several planets and lines) in your Venus Return Cycle connects with one gate (which may also include multiple planets and lines) in your Foundation Design. The connection between your Foundation gate and a Venus gate makes the channel created personal in nature. The resulting channel may also link two undefined centers in your design, further emphasizing and amplifying the personal theme.

Personal Channels can be **Developmental**, **Directional**, or formed through interactions with **one or more people** you meet. The specifics of the Personal Channels created in this cycle are discussed in greater detail later in this report.



Channel Theme: Personal - Developmental

A Personal Channel designated as developmental is activated by at least one Outer Planet (gate/line) in the Solar Return and at least one Planet (gate/line) from your Foundation Design. “Personal” in this context means you will experience the energy and themes of these channels throughout your Solar Year. It is personal because part of the channel is inherent to your Foundation Design, making it a significant personal development lesson tied to the nature of the channel created. Personal Channels can define the centers at one or both ends of the channel, and when a white (undefined) center is conditioned, it directly influences your Shadow Mind. The Shadow Mind often perceives these energies as highly significant, tempting you to make decisions based on them. However, it is crucial to recognize that your Inner Authority—not your Shadow Mind—determines their true importance. Without discernment, the Shadow Mind may mistake these energies as part of your identity, leading to incorrect decisions—or even correct decisions made with improper timing—which still result in a negative outcome.

Channel Theme: Personal - Directional

A Personal Channel designated as directional is activated by at least one Node (gate/line) in the Solar Return and at least one Planet (gate/line) from your Foundation Design. “Personal” in this context means you will experience the energy and themes of these channels throughout your Solar Year. It is personal because part of the channel is inherent to your Foundation Design, making it a significant personal lesson that can lead to a new direction aligned with the nature of the channel created. Personal Channels can define the centers at one or both ends of the channel, and when a white (undefined) center is conditioned, it directly influences your Shadow Mind. The Shadow Mind often perceives these energies as highly significant, tempting you to make decisions based on them. However, it is essential to recognize that your Inner Authority—not your Shadow Mind—determines their true importance. Without discernment, the Shadow Mind may mistake these energies as part of your identity, leading to incorrect decisions—or even correct decisions made with improper timing—which can still result in a negative directional outcome.

Channel Theme: Personal - Person

A Personal Channel designated as a person is activated by at least one Inner Planet (gate/line) in the Solar Return and at least one Planet (gate/line) from your Foundation Design. “Person” in this context means you will meet a person or people carrying the gate/line energy that creates the channel. The resulting channel will manifest one or more times during your Solar Year. It is personal because part of the channel is inherent to your Foundation Design, making it a significant personal lesson that can lead to new relationships aligned with the nature of the channel created. Personal Channels can define the centers at one or both ends of the channel, and when a white (undefined) center is conditioned, it directly influences your Shadow Mind. The Shadow Mind often perceives these energies as highly significant, tempting you to make decisions based on them. However, it is essential to recognize that your Inner Authority—not your Shadow Mind—determines their true importance. Without discernment, the Shadow Mind may mistake these energies as part of your identity, leading to incorrect decisions—or even correct decisions made with improper timing—which can still result in a negative outcome, particularly if you commit to the wrong person or people during this Solar Return.



Channel Theme: Educational - Developmental

An Educational Channel designated as developmental is activated by at least one Outer Planet, though it can also involve outer planets at both ends of the channel, or in some cases, an Inner Planet at one end while still being developmental. Development in this context means you will experience the energy and themes of these channels throughout your Solar Year. These themes are not inherent to your Foundation Design but offer an opportunity to learn about the channel being imprinted. Educational Channels can define the centers at one or both ends of the channel, and when a white (undefined) center is conditioned, it directly influences your Shadow Mind. The Shadow Mind often perceives these energies as highly significant and may tempt you to make decisions based on them. However, it is essential to recognize that your Inner Authority—not your Shadow Mind—determines their true importance. Without discernment, the Shadow Mind can mistake these energies as part of your identity, leading to incorrect decisions, or even correct decisions made with the wrong timing, which still results in a negative outcome.

Channel Theme: Educational - Directional

An Educational Channel designated as directional is activated by at least one of the 4 Solar Nodal Gates and Lines. Nodal activations represent your direction for the year. A directional Channel can also involve an Outer or Inner Planet at one end, but due to the nodal imprint, it is still classified as directional. Directional, in this context, means you will experience the energy and themes of these channels throughout your Solar Year. These themes are not inherent to your Foundation Design but provide an opportunity to learn about the channel being imprinted. Educational Channels can define the centers at one or both ends of the channel, and when a white (undefined) center is conditioned, it directly influences your Shadow Mind. The Shadow Mind often perceives these energies as highly significant, tempting you to make decisions based on them. However, it is crucial to remember that your Inner Authority—not your Shadow Mind—determines their true importance. If the Shadow Mind makes decisions based on directional channel input, it can steer your life in an entirely new and often incorrect direction. Without discernment, the Shadow Mind may mistake these energies as part of your identity, leading to poor decisions—or even correct decisions made with the wrong timing—resulting in a negative outcome as your life begins to shift off course.

Channel Theme: Educational - People

An Educational Channel designated as 'people' is activated by inner planets at both ends of the channel. In this context, "people" means you will experience the energy and themes of these channels at specific moments during your Solar Year. These themes are not inherent to your Foundation Design but provide an opportunity to learn about the channel being imprinted. The channel can represent people within auric contact with you, conditioning you in the moment, but it is unlikely to hold long-term significance for your overall life. Educational Channels can also define the centers at one or both ends of the channel, and when a white (undefined) center is conditioned, it directly influences your Shadow Mind. The Shadow Mind often perceives these energies as highly significant, tempting you to make decisions based on them. However, it is crucial to recognize that your Inner Authority—not your Shadow Mind—determines their true importance. Without discernment, the Shadow Mind may mistake these energies as part of your identity, leading to incorrect in-the-moment decisions, or even correct decisions made with the wrong timing, resulting in a negative outcome.



Personal Channels

A Personal Channel is created when a gate from your Venus Return Cycle (which can include multiple planets and lines) connects with a gate from your Foundation Design (also potentially containing several planets and lines). This connection between a gate in your Foundation Design and one in your Venus imprinting results in a channel that is considered personal in nature. Personal Channels can manifest as **developmental** opportunities, **directional** themes, or through interactions with a **person** you encounter during the Venus cycle.

Channel 0108: Inspiration	Developmental
Channel 2551: Initiation	Experiential, Developmental, Person
Channel 3041: Recognition	Developmental
Channel 1949: Synthesis	Person



Activations of Channel 0108: Inspiration

	P/D	Gate & Line	Fixing	Filter	Venus Return
Foundation	Personality	1.5	Detriment	Neptune	-
Foundation	Design	1.4	None	Neptune	-
Venus	Personality	8.5	None	Uranus	Developmental
Venus	Design	8.4	None	Uranus	Developmental

Channel 0108: Inspiration

A Design of being a creative Role Model

Channel 0108 operates as a natural beacon of inspiration. Its essence is to stand out boldly, embodying unique self-expression without hesitation. This channel carries an innate creative flair and expresses itself in distinctly original ways. Through its authentic expression, it illuminates the path for others to be brave and different.

As part of the Knowing circuit, this channel manifests as natural leadership, but not in the conventional sense. Its leadership quality emerges through setting an example, demonstrating to others how to confidently walk their own path. The channel's impact flows from its distinctive presence - whether through style, appearance, or unique modes of expression that capture attention. A crucial aspect of this channel is its inherent resistance to comparison with others.

This channel exists to manifest uniqueness. Being a Projected channel, its expression requires recognition and invitation from others to fully shine. When this recognition occurs, the channel receives its natural due respect. The channel's power lies in authentic self-expression - a force that naturally draws recognition and inspires others to embrace their own creative spark and courage.

Components

Channel Type: Projected

Energy Family: Knowing (Individual) - Empowerment

Gate 1: The Creative: Creation as a primal force. The energy potential to manifest inspiration without limitation. Quarter of Mutation.

Gate 8: Holding Together: The basic worth realized in contributing individual efforts to group goals. Quarter of Civilization.



Foundation

Foundation Filter: Neptune

Like a shimmering veil between worlds, Neptune represents our conscious relationship to illusion and the hidden realms. This ethereal force shapes our connection to the mysterious and unseen, conducting our awareness through a matrix of dreams, mystical sensitivity, and transcendent possibility. As the archetypal weaver of veils, Neptune pulses with visionary frequencies, spiritual longing, and the profound ability to transform ordinary perception into extraordinary vision. Its energy manifests as both enchanting and dissolving - from the fantasies that inspire universal love to the illusions that cloud clear seeing. Through Neptune, we learn to navigate the waters of uncertainty, transforming distraction into spiritual insight, gradually evolving from confusion to enlightened awareness as we develop discernment. As a personality activation Neptune operates Misinformation for our Conscious Mind through the Learning Vertical and The Heart Lateral.

Gate 1: The Creative

Creation as a primal force.

Gate 1 represents a profoundly transformative creative force driven by an innate need for unique self-expression. This creativity is not rooted in awareness or logic but flows from its distinct individual direction, often demanding attention. The well of creativity within this gate is limitless, introducing fresh and innovative perspectives to the world. While Gate 1 may thrive in moments of solitary creation, its true fulfillment comes through interaction with others, where its uniqueness can inspire and influence. Its role is not about being the best but about being authentically new and different, carving a path that others may eventually follow. However, this drive for originality is not always recognized or appreciated, which can lead to feelings of melancholy when its distinctiveness goes unnoticed or unvalued.

The creative energy of Gate 1 moves in pulses, bringing bursts of inspiration that demand expression. When fully immersed in the creative flow, concerns about goals, recognition, or external validation fade away, leaving only the joy of creation itself. Yet, when this creativity remains unexpressed, sadness or frustration may arise, as the energy of this gate is meant to be shared with the world. As a trailblazer of self-expression, Gate 1 is a gift to humanity, offering a unique and empowering force that inspires change and transformation simply by being an authentic example. Even if its contributions are not always immediately understood, its mutative influence has the power to leave a lasting impact, challenging others to see the world through a new lens.

Additional Gate Information:

- Incarnation Crosses: Sphinx, Self-Expression, Defiance
- Incarnation Quarter: Spirit (Mutation) - Scorpio
- Energy Circuit: Knowing (Individual)
- Amino Acid: Lysin
- Anatomy: Liver
- Gene Keys: Entropy (Depressive-Frenetic) - Freshness - Beauty



Line 5: The energy to attract society - Detriment

↓ **Uranus:** Uranus in detriment, where eccentricity can limit endurance. Eccentricity that though attractive will limit the drive.

- Line Quality: Projected on as a universalized quality.

The fifth line projection naturally draws social attention and expectations around creative potential, requiring significant endurance to maintain authentic creative development while under society's gaze. This position brings the challenge of navigating constant projection without becoming fixed in a creative persona, demanding the strength to channel social attention productively while staying committed to genuine creative work.

↓ **Detriment (Uranus):**

Under Uranus's detriment influence, the Line experiences eccentricity becoming a substitute for genuine creative development. The pressure of social projection may lead to emphasizing persona over process, where maintaining an image of creativity takes precedence over actual creative work.

The Line's challenge lies in avoiding the trap of performing the role of the creative person rather than engaging in genuine creative development. Uranus in detriment can manifest as increasing eccentricity to maintain social attention, potentially limiting true creative endurance.

Foundation Filter: Neptune

Like a mysterious mist enveloping the form, the Design Neptune orchestrates our body's profound relationship with fluids and hydration. This aqueous force shapes our form's moisture balance and liquid rhythms, conducting our cellular processes through a matrix of circulation, absorption, and subtle fluid regulation. As the form's archetypal water bearer, Design Neptune pulses with liquid frequencies, hydration patterns, and the innate ability to transform fluid distribution into vital sustenance. Its energy manifests as both flowing and veiling - from the intricate dance of cellular moisture to the mysterious currents that shroud our physical processes. Through the Design Neptune, our form learns to maintain its delicate fluid harmony, transforming water into life-sustaining essence, unconsciously moving between states of hydration and balance as our form operates. As a design activation Design Neptune controls our body Hydration through The Satori Vertical, The Liquid Lateral and the Martial Diamond.

Gate 1: The Creative

Creation as a primal force.

Gate 1 represents a profoundly transformative creative force driven by an innate need for unique self-expression. This creativity is not rooted in awareness or logic but flows from its distinct individual direction, often demanding attention. The well of creativity within this gate is limitless, introducing fresh and innovative perspectives to the world. While Gate 1 may thrive in moments of solitary creation, its true fulfillment comes through interaction with others, where its uniqueness can inspire and influence. Its role is not about being the best but about being authentically new and different, carving a path that others may eventually follow. However, this drive for originality is not always recognized or appreciated, which can lead to feelings of melancholy when its distinctiveness goes unnoticed or unvalued.

The creative energy of Gate 1 moves in pulses, bringing bursts of inspiration that demand expression. When fully immersed in the creative flow, concerns about goals, recognition, or external validation fade away, leaving only the joy of creation itself. Yet, when this creativity remains unexpressed, sadness or frustration may arise, as the energy of this gate is meant to



be shared with the world. As a trailblazer of self-expression, Gate 1 is a gift to humanity, offering a unique and empowering force that inspires change and transformation simply by being an authentic example. Even if its contributions are not always immediately understood, its mutative influence has the power to leave a lasting impact, challenging others to see the world through a new lens.

Additional Gate Information:

- Incarnation Crosses: Sphinx, Self-Expression, Defiance
- Incarnation Quarter: Spirit (Mutation) - Scorpio
- Energy Circuit: Knowing (Individual)
- Amino Acid: Lysin
- Anatomy: Liver
- Gene Keys: Entropy (Depressive-Frenetic) - Freshness - Beauty

Line 4 - Aloneness as the medium of creativity - No Fixing

The Tension of Inner Light.

↑ Earth: The Earth exalted as the symbol of personal perspective manifested outside of influence, where the potential magic of inspiration is diluted. Creativity that must develop outside of influence.

↓ Jupiter: Where the potential magic of inspiration is diluted. The need to influence that abandons aloneness and limits creativity.

- Line Quality: Fixed on externalizing its single track quality.

The fourth line position brings a fixed understanding that authentic creativity requires protected solitude and sacred space to develop fully. This awareness recognizes that genuine creative mutation can only emerge when properly insulated from external influences, though success itself can potentially interrupt the necessary cycle of returning to creative isolation.

↑ Exaltation (Earth):

The Line's exalted Earth influence manifests as a grounded personal perspective that flourishes in solitude. This fourth-line position understands inherently that true creativity requires sacred space away from external influences. The Earth's stability supports the natural fixed awareness that authentic creation emerges only through periods of conscious isolation.

Through the Earth's grounding influence, this line naturally understands that creativity must develop outside of influence, not as a rejection of the world, but as a prerequisite for authentic expression. This creates a powerful foundation for externalization where unique perspective can manifest without dilution or compromise.

↓ Detriment (Jupiter):

Under Jupiter's detriment influence, the line experiences the potential magic of inspiration becoming diluted through an excessive focus on externalization. While the creative process remains protected from direct interference, there may be fixation on sharing or distributing what's been created, potentially interrupting the ongoing cycle of creativity.

The Line's challenge lies in resisting the urge to abandon creative solitude once something worthy has emerged. Jupiter's expansive nature can manifest as becoming caught up in the marketing or distribution of creation, rather than returning to the creative source.



Venus Return

Conscious Uranus - Venus Return: Developmental

The Cycle Uranus radiates as a conscious field of transformative frequencies, influencing your personality's relationship with innovation, freedom, and individuality through the gate and line it imprints. By forming a channel with your foundational design, this Uranian activation acts as a guiding developmental force, inviting your mind to break free from outdated patterns and consciously explore new perspectives. Uranus inspires you to align with your authentic self, consciously embracing change, originality, and revolutionary insight as tools for growth.

Uranus' developmental influence consciously encourages you to balance personal freedom with collective progress, using innovation to create meaningful change. Through the gate and line it activates, Uranus supports your mind's ability to embrace transformation and navigate the unknown with courage and creativity. As the cycle progresses, you will consciously engage with the themes of individuality and progress, integrating Uranus' disruptive yet liberating energy. This process allows you to realign your personality with its highest potential, fostering transformation and authentic expression.

Gate 8: Holding Together

The basic worth realized in contributing individual efforts to group goals.

Gate 8 serves as a primary communicator of individual identity, offering a unique and creative contribution to collective progress. Unlike simply presenting ideas for discussion, this gate demonstrates innovative concepts in tangible, impactful ways, often leading to recognition and material rewards. As part of a projected channel, Gate 8 must independently forge its own path, allowing others to naturally recognize its value. It carries a gift for highlighting creativity, not only its own but also that of others, acting as a conduit for spreading new ideas and forms. Its role is not to lead or command, but to empower and provide an outlet for individuality and originality. By uplifting and promoting the unique talents of those around it, Gate 8 ensures that its own contributions are acknowledged and appreciated.

This gate thrives on walking its distinct path, even if others are slow to follow. However, when its individuality and creativity go unnoticed, it may experience moments of melancholy. Patience is essential, as originality often requires time for others to fully understand and embrace. Gate 8 has the potential to act as a catalyst for societal evolution, using its creative expression to influence collective progress. By staying true to its unique vision and trusting in the timing of recognition, this gate becomes a vital force for spreading innovation and fostering impactful change within the collective.

Additional Gate Information:

- Incarnation Crosses: Contagion, Contribution, Uncertainty
- Incarnation Quarter: Form (Civilization) - Taurus
- Energy Circuit: Knowing (Individual)
- Amino Acid: Phenylalanine
- Anatomy: Thyroid
- Gene Keys: Mediocrity (Wooden-Artificial) - Style - Exquisiteness



Line 5: Dharma - No Fixing

Holding together does not exclude eventual separation. Successful union, after a proper term will encourage separation. The fledgling once mature is expected to leave the nest. This is right action which does not harm the integrity of the union.

↑ Jupiter: The teacher. Contribution as part of a process of sharing that accepts and expects limitation, exemplified in teaching.

↓ Sun: The parent that cannot let go of the child, understanding only, that its authority is being challenged. Contribution as an end in itself that neither accepts nor expects limitation, exemplified by the parent that cannot let go of the child.

- Line Quality: Completes and universalizes the theme of the Hexagram.

The fifth line understands that all teaching relationships must eventually end, allowing it to guide others while maintaining healthy boundaries. While this enables it to naturally fulfill its role as a teacher, it can resist letting go when it's time, leading to burnout from trying to help everyone indefinitely.

↑ Exaltation (Jupiter):

Like a piano teacher who knows when to step aside, this line excels at providing guidance and then letting students move on when they're ready. It understands that being a good teacher means preparing others to eventually not need you anymore.

Others naturally look to this line for direction, and when exalted, it knows how to set clear limits on its teaching role. It can provide what's needed without getting overly attached to students or trying to teach beyond its expertise.

↓ Detriment (Sun):

In detriment, this line has trouble letting go of its students or its guidance role. Like a parent who can't accept their child's independence, it holds on when it should step back.

Because others constantly seek its guidance, it can become overwhelmed by trying to help everyone who asks. Without healthy boundaries, it exhausts itself by continuing to teach even when it's no longer helpful or appropriate.



Unconscious Uranus - Venus Return: Developmental

The Cycle Unconscious Uranus radiates as a field of distinctive and electric frequencies, influencing your form's unique physical patterns, characteristic movements, and natural rhythms. Through the gate and line it imprints, and by forming a channel with your foundational design, Uranus acts as a deeply rooted developmental force, shaping your body's capacity for spontaneous impulse, kinetic originality, and instinctive innovation. This influence operates beneath conscious awareness, guiding your form through patterns of unexpected motion and authentic expression. As the form's archetypal pattern-breaker, Uranus aligns with the body's inherent ability to transform physical convention into distinctive expression, shifting from predictable to unique rhythms as it moves through this cycle.

Uranus's developmental influence encourages your body to refine its capacity for original movement, gradually evolving from standard mechanics to a fully expressed and distinctive gait. By forming a channel with your foundational design, this planetary force unconsciously strengthens your form's ability to embody its unique rhythms, shaping its originality and authentic presence. As the cycle progresses, your form will integrate Uranus's lessons of spontaneity, innovation, and distinctive motion, responding instinctively to its electric and transformative frequencies.

Gate 8: Holding Together

The basic worth realized in contributing individual efforts to group goals.

Gate 8 serves as a primary communicator of individual identity, offering a unique and creative contribution to collective progress. Unlike simply presenting ideas for discussion, this gate demonstrates innovative concepts in tangible, impactful ways, often leading to recognition and material rewards. As part of a projected channel, Gate 8 must independently forge its own path, allowing others to naturally recognize its value. It carries a gift for highlighting creativity, not only its own but also that of others, acting as a conduit for spreading new ideas and forms. Its role is not to lead or command, but to empower and provide an outlet for individuality and originality. By uplifting and promoting the unique talents of those around it, Gate 8 ensures that its own contributions are acknowledged and appreciated.

This gate thrives on walking its distinct path, even if others are slow to follow. However, when its individuality and creativity go unnoticed, it may experience moments of melancholy. Patience is essential, as originality often requires time for others to fully understand and embrace. Gate 8 has the potential to act as a catalyst for societal evolution, using its creative expression to influence collective progress. By staying true to its unique vision and trusting in the timing of recognition, this gate becomes a vital force for spreading innovation and fostering impactful change within the collective.

Additional Gate Information:

- Incarnation Crosses: Contagion, Contribution, Uncertainty
- Incarnation Quarter: Form (Civilization) - Taurus
- Energy Circuit: Knowing (Individual)
- Amino Acid: Phenylalanine
- Anatomy: Thyroid
- Gene Keys: Mediocrity (Wooden-Artificial) - Style - Exquisiteness



Line 4: Respect - No Fixing

The gift of naturally recognizing the contributions of others and particularly, the acknowledgement of those who lead by example.

↑ Jupiter: The uncompromising drive to assimilate. The drive to contribute and be an example to and for others.

↓ Mercury: In a group where limitation is transcended, reason alone cannot predict individual worth. As an example, the acknowledged leader of an athletic team is not necessarily the most talented. A gift for contribution that is not conditioned by limitations.

- Line Quality: Fixed on externalizing the theme of the Hexagram.

The fourth line position recognizes and facilitates unique individual potential, bridging creative contributions with collective recognition. While this fixed focus supports valuable difference, it creates tension with conventional metrics as authentic individual expression transcends comparison.

↑ Exaltation (Jupiter):

When exalted, this fixed fourth line quality manifests through an uncompromising drive to recognize and facilitate valuable individual contributions. Like the art dealer who recognizes genius in an unknown artist, it has a natural gift for seeing the value of individual contributions and helping them reach the collective.

This opportunistic nature finds fulfillment in being the bridge that connects unique individual contributions to collective recognition. This manifests not through seeking to be the best, but through authentically recognizing and supporting what is different and valuable.

↓ Detriment (Mercury):

In detriment, this line becomes trapped trying to measure and quantify unique contributions through conventional metrics. The fixed focus gets caught in comparative assessment rather than recognizing authentic value.

The drive to facilitate contribution becomes distorted when filtered through collective metrics of success or talent. The opportunistic nature struggles when trying to justify potential through conventional frameworks. This teaches that being the "best" is irrelevant to individual contribution - the role is to recognize and support authentic difference rather than comparative excellence.



Activations of Channel 2551: Initiation

	P/D	Gate & Line	Fixing	Filter	Venus Return
Foundation	Personality	51.3	Juxtapose	Venus	-
Foundation	Personality	51.5	Exalted	Jupiter	-
Venus	Personality	25.2	None	Sun	Experiential
Venus	Personality	25.4	Exalted	Neptune	Developmental
Venus	Personality	51.3	Juxtapose	Moon	Person
Venus	Personality	51.3	Juxtapose	Venus	Person
Venus	Design	25.2	None	Neptune	Developmental

Channel 2551: Initiation

A Design of Needing to be First.

The 2551 Channel, known as the Channel of Initiation, carries a dynamic and courageous energy, driven to leap into the unknown and take decisive action. Fueled by an inner warrior spirit, it paves its own path, viewing challenges as opportunities for growth. This channel thrives on pushing limits, embracing competition, and surprising both itself and others in the pursuit of its unique and transformative journey. By testing its endurance, the 2551 often uncovers profound and even mystical truths about life and itself.

At its core, the 2551 Channel is about personal transformation and the discovery of inner strength. It is not concerned with creating change for others but rather focuses on its own journey of growth and self-realization. This energy propels the individual to pioneer new paths and take bold action, often serving as an example of courage and determination. While others may find empowerment in its fearless nature, the 2551's true purpose lies in its own evolution and initiation into new possibilities.

By embracing uncertainty and trusting its inner strength, the 2551 Channel fulfills its role as a trailblazer and a catalyst for its own transformation. It thrives on courageous action, demonstrating the daring to explore the unknown. Through its willingness to confront challenges head-on, this channel shapes its own path, uncovering its unique purpose and empowering others as a byproduct of its authentic journey.

Components

Type: Projected Channel

Energy Circuit: Centering - Empowerment

Gate 25: Innocence: The perfection of action through on uncontrived and spontaneous nature. Quarter of Initiation.

Gate 51: The Arousing: The ability to respond to disorder and shock through recognition and adaptation. Quarter of Initiation.



Foundation

Foundation Filter: Venus

Like a discerning curator of life's beauty, Venus represents our conscious values and attractions, illuminating what we genuinely appreciate and desire in our journey. This refined force shapes our aesthetic sensibilities and relationship patterns, guiding our choices through an intricate web of personal preferences, artistic inclinations, and social connections. As the archetypal principle of harmony, Venus pulses with sophisticated taste, emotional refinement, and the profound ability to recognize what we truly value. Its energy manifests as both attractive and selective - from the magnetic pull toward beauty to the careful discrimination that defines our standards. Through Venus, we learn to articulate our values, transforming raw desires into cultured appreciation, gradually evolving from superficial attractions to deeper understanding of worth as we develop discernment. As a personality activation Venus controls The Standard through the Heart Lateral and Alpha Vertical.

Gate 51: The Arousing

The ability to respond to disorder and shock through recognition and adaptation.

Gate 51 represents a powerful force of willpower that responds to disorder and shock with a drive for recognition and adaptation. As part of the Centering Energy Family, it stands for individual initiative and a fierce competitive nature. This gate naturally tests itself, striving for competitive primacy and pushing boundaries to prove its strength. Its energy is bold and unpredictable, invoking actions that can either appear reckless or display great courage, as it ventures into situations where few dare to go. However, its effectiveness depends on trusting Inner Authority to temper its competitive spirit with wisdom, ensuring that courage does not lead to impulsiveness. Gate 51 commits its energy only when situations demand competitive willpower or the ability to respond to shock, avoiding unnecessary risks. When guided by the mind rather than Inner Authority, decisions influenced by this gate can lead to inconsistency and potentially harmful outcomes.

Gate 51 looks to connect with Gate 25 to form the Channel of Initiation, enabling a leap into pioneering exploration and new directions. This channel brings an unpredictable and electrifying energy that disrupts comfort zones, empowering others to find their center and broaden their perspectives. Its capacity to deliver shock and inspire change can lead to profound transformation, but its unpredictable nature also leaves it prone to melancholy when life lacks excitement or challenge. As the only individual gate in the Heart Center, Gate 51 carries a distinct energy of personal willpower and assertion, setting it apart from the tribal focus of the other gates. Its uniqueness lies in its ability to balance the disruptive power of shock with courage and wisdom, using its competitive drive to inspire and lead others into uncharted territory while staying aligned with its deeper purpose.

Additional Gate Information:

- Incarnation Crosses: Penetration, Shock, Clarion
- Incarnation Quarter: Mind (Initiation) - Aries
- Energy Circuit: Centering
- Amino Acid: Arginin
- Anatomy: Gall Bladder
- Gene Keys: Agitation (Cowardly / Hostile) - Initiative - Awakening



Line 3: Adaptation - Juxtaposed

↑ Sun: The life-sustaining awareness that thinks on its feet and thus creates opportunities. The power of spontaneity in times of challenge.

↓ Jupiter: The destabilization that occurs when one's field of normal activity is radically and unpredictably disturbed, where the tendency is withdrawal rather than adaptation. The ego that may be destabilized in times of challenge.

- Line Quality: Attuning and adapting to a trial and error process.

Line 3 in Gate 51 navigates shock through a natural trial and error process. This line's adaptability allows it to develop authentic wisdom about when to engage with or withdraw from challenging situations. Through direct experience, Line 3 discovers its true competitive nature, refining its approach with each encounter.

↑ Exaltation (Sun):

The Sun grants Line 3 a natural adaptability that thrives in chaos, enabling it to create opportunities through spontaneous responsiveness. For example, when faced with an unexpected crisis, Line 3 reflexively adjusts its approach, using its trial and error nature to find creative solutions. This ability to stay present and respond to the unique demands of each moment allows Line 3's competitive spirit to emerge authentically.

Through each engagement, Line 3 refines its capacity to react quickly and effectively. The Sun's influence enhances its ability to transform uncertainty into growth, building a foundation of wisdom and mastery. Its natural adaptability becomes a source of protection, helping it navigate shocks with creative resilience.

↓ Detriment (Jupiter):

Jupiter introduces a tendency for Line 3 to become destabilized when faced with extreme unpredictability. For instance, in situations where challenges radically deviate from familiar patterns, Line 3 may retreat instead of adapting. This withdrawal can prevent it from fully accessing its natural competitive spirit and creative problem-solving abilities.

When shock exceeds its current capacity for adaptation, Line 3's trial and error process may falter, leading to hesitation or avoidance. The key lies in its ability to differentiate between situations that require strategic retreat and those that call for creative engagement. By honoring both its need for safety and its capacity for spontaneous action, Line 3 develops the wisdom to handle even the most destabilizing circumstances.



Foundation Filter: Jupiter

Like a generous sage expanding the horizons of understanding, Jupiter represents our conscious approach to rules, laws and protection, orchestrating how we seek and establish security. This benevolent force shapes our philosophical outlook and belief systems, conducting our aspirations through an intricate web of wisdom, faith, and higher learning. As the archetypal seeker of enlightenment, Jupiter pulses with optimistic growth, abundant possibilities, and the profound ability to transform knowledge into protection. Its energy manifests as both magnanimous and fortune-bearing - from the lucky chances that bring wealth to the deeper principles that guard our future. Through Jupiter, we learn to establish our foundations, transforming hope into structured security, gradually evolving from excess to measured abundance as we develop wisdom. As a personality activation Jupiter controls Rules through the Mind Lateral and Outer Authority Vertical.

Gate 51: The Arousing

The ability to respond to disorder and shock through recognition and adaptation.

Gate 51 represents a powerful force of willpower that responds to disorder and shock with a drive for recognition and adaptation. As part of the Centering Energy Family, it stands for individual initiative and a fierce competitive nature. This gate naturally tests itself, striving for competitive primacy and pushing boundaries to prove its strength. Its energy is bold and unpredictable, invoking actions that can either appear reckless or display great courage, as it ventures into situations where few dare to go. However, its effectiveness depends on trusting Inner Authority to temper its competitive spirit with wisdom, ensuring that courage does not lead to impulsiveness. Gate 51 commits its energy only when situations demand competitive willpower or the ability to respond to shock, avoiding unnecessary risks. When guided by the mind rather than Inner Authority, decisions influenced by this gate can lead to inconsistency and potentially harmful outcomes.

Gate 51 looks to connect with Gate 25 to form the Channel of Initiation, enabling a leap into pioneering exploration and new directions. This channel brings an unpredictable and electrifying energy that disrupts comfort zones, empowering others to find their center and broaden their perspectives. Its capacity to deliver shock and inspire change can lead to profound transformation, but its unpredictable nature also leaves it prone to melancholy when life lacks excitement or challenge. As the only individual gate in the Heart Center, Gate 51 carries a distinct energy of personal willpower and assertion, setting it apart from the tribal focus of the other gates. Its uniqueness lies in its ability to balance the disruptive power of shock with courage and wisdom, using its competitive drive to inspire and lead others into uncharted territory while staying aligned with its deeper purpose.

Additional Gate Information:

- Incarnation Crosses: Penetration, Shock, Clarion
- Incarnation Quarter: Mind (Initiation) - Aries
- Energy Circuit: Centering
- Amino Acid: Arginin
- Anatomy: Gall Bladder
- Gene Keys: Agitation (Cowardly / Hostile) - Initiative - Awakening



Line 5: Symmetry - Exalted

↑ **Sun:** Perfected illumination that in grasping the nature of the shock, can transform its normal patterns into a symmetrical adaptation that rides the shock and avoids its devastation. The perfection of the warrior ego through instinctive adaptation.
- Line Quality: Projected on as a universalized quality.

Line 5 in Gate 51 carries a projected quality of courage and willpower that others naturally respond to, whether it is authentically embodied or not. People project expectations of bravery onto Line 5, creating opportunities for recognition and success if these projections are fulfilled. However, failing to meet these expectations can lead to criticism or condemnation from others.

↑ **Exaltation (Sun):**

The Sun grants Line 5 the ability to handle shock by aligning with its nature rather than resisting it. For example, like a skilled martial artist who redirects force instead of opposing it directly, Line 5 instinctively adapts to the momentum of shock, maintaining balance and avoiding devastation. This fluidity demonstrates the perfection of courage through fluid adaptation.

Line 5's projected energy creates opportunities to model this mastery for others. By remaining unattached to fixed responses or rigid strategies, it finds innovative ways to navigate challenges. The Sun's influence illuminates Line 5's adaptability, allowing it to embody courage in a way that fulfills others' expectations when done authentically and without ego.



Venus Return

Conscious Sun - Venus Return: Experiential

During this cycle, the Sun acts as a conditioning force, infusing your experience with radiant energy that illuminates the journey of self-expression. Rather than being your core identity, its influence creates an experience where you interact with the themes of confidence, self-awareness, and creative potential. This energy pulses through your life in this cycle, guiding you to explore how your inner light can be shaped into outer recognition. The Sun's conditioning invites you to navigate the balance between integrating its power and radiating it outward, offering opportunities to experiment with the natural flow of self-expression and discovery.

Through this experiential process, the Sun provides a framework for learning and refinement, revealing how authenticity can emerge as you engage with its influence. It supports your evolution from exploring potential to manifesting presence, allowing you to witness and respond to the dynamic interplay of identity, creativity, and consciousness within the cyclical rhythm of life.

Gate 25: Innocence

The perfection of action through on uncontrived and spontaneous nature.

Gate 25 embodies a profound capacity for universal, unconditional love that transcends individuals and encompasses all of existence. This "cool" and impersonal love reflects a deep compassion for life in its entirety, offering others a sense of self-acceptance simply by being in its presence. It carries the challenge of maintaining a state of unaffected innocence despite the trials and hardships of life. Each experience, no matter how difficult, has the potential to deepen this innate innocence and naturalness, reinforcing its connection to the sacredness of life. Mystical in nature, Gate 25 often resonates with the energy of a shaman or priestess, embodying an intuitive understanding of life's deeper, spiritual dimensions. Themes of blood, whether symbolic or literal, may recur in its experiences, as this gate represents "the blood within the vessel of love," tying it to the essence of vitality and connection.

This gate's universal love can sometimes be misunderstood, as its affection extends equally to all things, from a sunrise or a crystal to a person. Its unique perspective finds meaning in life's interconnectedness, transcending the apparent pointlessness of existence by embracing the sacred unity of all that is. Gate 25 serves as a vessel for universal love, radiating a profound sense of acceptance and unity to the world. Its energy naturally conditions others, inviting them to embrace themselves and life as it is. Through its deep compassion and spiritual clarity, Gate 25 brings an extraordinary sense of meaning and harmony to the human experience.

Additional Gate Information:

- Incarnation Crosses: Vessel of Love, Innocence, Healing
- Incarnation Quarter: Mind (Initiation) - Aries / Pisces
- Energy Circuit: Centering
- Amino Acid: Arginin
- Anatomy: Blood
- Gene Keys: Constriction (Ignorant-Cold) - Acceptance - Universal Love



Line 2: The Existentialist - No Fixing

Devotion and dedication to the now.

↑ **Mercury:** The perfection of the intellect through concentration and focus on what is, rather than, what could be or has been. The innocence of the Self and its protection can only be maintained in the now.

↓ **Mars:** A dedication that can never be free of personal motivation and its attendant projections. A lack of innocence in the now that risks protection through projection.
- Line Quality: Projection inwards. No subjective ability to see in. The natural.

The second line of Gate 25 embodies a natural state of pure existential presence, where love arises spontaneously through complete immersion in the now. This innate orientation to immediate experience creates a profound innocence, untainted by external projections or mental constructs. The second line's gift lies in its simple devotion to what is, allowing universal love to flow effortlessly without interference or self-consciousness.

↑ Exaltation (Mercury):

Mercury's influence highlights the second line's ability to derive intellectual clarity directly from pure presence rather than analysis. For example, by remaining fully immersed in the present moment, the second line experiences a deeper understanding that arises naturally, unclouded by the need to reach for answers or engage in mental construction. The wisdom revealed is a result of direct experience, leading to an organic connection to universal love.

This state of innocence protects the second line from the distortions of mental projection, creating a foundation where love and wisdom flow effortlessly. By staying anchored in the now, the second line demonstrates how understanding emerges not through intellectual effort, but through surrender to immediate experience.

↓ Detriment (Mars):

Mars introduces a challenge for the second line by exposing it to external recognition, which can disrupt its natural state and introduce self-consciousness. For instance, when others project motives or attempt to reward the second line's motiveless expression, its innocent presence can become clouded. This creates tension, as worldly expectations threaten to pull the second line away from its existential foundation.

This vulnerability to external projections can temporarily disconnect the second line from its natural flow of universal love. The paradox arises when others' recognition of the second line's purity inadvertently compromises it, making it difficult to maintain the profound simplicity of its authentic expression.



Conscious Neptune - Venus Return: Developmental

The Cycle Neptune radiates as a conscious field of visionary frequencies, influencing your personality's relationship with imagination, intuition, and spiritual connection through the gate and line it imprints. By forming a channel with your foundational design, this Neptunian activation serves as a developmental force, inviting your mind to consciously explore higher states of awareness. Neptune's energy acts as a veiling force, cloaking the deeper truths of its influence in mystery and subtlety. It cannot be fully penetrated; instead, it reveals itself gradually, often through intuition or creative inspiration, rather than direct understanding.

Neptune's developmental influence encourages conscious surrender to the unknown, inviting you to embrace its veiled nature as a source of spiritual insight and imaginative power. Through the gate and line it activates, Neptune supports your mind's ability to navigate the intangible, dissolving boundaries between reality and possibility. As the cycle unfolds, you will consciously engage with Neptune's elusive energy, integrating its themes of compassion, creativity, and higher awareness. This process allows you to align with Neptune's veiled frequencies, cultivating a deeper connection to life's mysteries and the infinite potential of imagination.

Gate 25: Innocence

The perfection of action through on uncontrived and spontaneous nature.

Gate 25 embodies a profound capacity for universal, unconditional love that transcends individuals and encompasses all of existence. This "cool" and impersonal love reflects a deep compassion for life in its entirety, offering others a sense of self-acceptance simply by being in its presence. It carries the challenge of maintaining a state of unaffected innocence despite the trials and hardships of life. Each experience, no matter how difficult, has the potential to deepen this innate innocence and naturalness, reinforcing its connection to the sacredness of life. Mystical in nature, Gate 25 often resonates with the energy of a shaman or priestess, embodying an intuitive understanding of life's deeper, spiritual dimensions. Themes of blood, whether symbolic or literal, may recur in its experiences, as this gate represents "the blood within the vessel of love," tying it to the essence of vitality and connection.

This gate's universal love can sometimes be misunderstood, as its affection extends equally to all things, from a sunrise or a crystal to a person. Its unique perspective finds meaning in life's interconnectedness, transcending the apparent pointlessness of existence by embracing the sacred unity of all that is. Gate 25 serves as a vessel for universal love, radiating a profound sense of acceptance and unity to the world. Its energy naturally conditions others, inviting them to embrace themselves and life as it is. Through its deep compassion and spiritual clarity, Gate 25 brings an extraordinary sense of meaning and harmony to the human experience.

Additional Gate Information:

- Incarnation Crosses: Vessel of Love, Innocence, Healing
- Incarnation Quarter: Mind (Initiation) - Aries / Pisces
- Energy Circuit: Centering
- Amino Acid: Arginin
- Anatomy: Blood
- Gene Keys: Constriction (Ignorant-Cold) - Acceptance - Universal Love



Line 4: Survival - Exalted

The nature of true innocence can be maintained regardless of circumstances.

↑ Venus & Jupiter: The beauty of the rose in the garbage dump. Jupiter is also exalted. The highest principles even amongst the greatest decadence. The spiritual warrior; the innocence maintained regardless of circumstances. No polarity.

- Line Quality: Fixed on externalizing its single track quality.

The fourth line of Gate 25 represents a fixed, one-tracked quality of maintaining true innocence regardless of external circumstances. Through its transpersonal awareness, the fourth line recognizes the relationship between Self and Ego, demonstrating how motiveless action can persist even in challenging environments. This single-track dedication to universal love creates a living example of spiritual warriorship.

↑ Exaltation (Venus & Jupiter):

The combined exaltation of Venus and Jupiter in the fourth line creates a powerful framework for maintaining innocence regardless of the situation. Like a single flower growing through cracked pavement, the fourth line's fixed nature becomes a living demonstration that beauty and truth can persist even in the most unlikely or challenging environments. For example, in a tumultuous social environment, the fourth line continues to embody universal love, inspiring others to find hope and meaning amid chaos.

This unwavering focus allows the fourth line to transform theoretical principles into lived experiences. By consistently staying aligned with existential truth, the fourth line becomes a guide for others, showing how spiritual warriorship can manifest in practical, everyday actions.



Person: Conscious Moon - Venus Return: Person

In this cycle, you will meet someone who embodies the qualities of the Moon, through this gate and line. This individual will reflect the Moon's fluid and nurturing energy, guiding focus and influencing the emotional landscape with their sensitivity and emotional intelligence within the channel they create with you. They will naturally attune to life's subtle currents, encouraging the processing of feelings, memories, and experiences in ways that bring clarity and growth.

Since this connection creates definition through a channel, their emotional awareness and attunement will help illuminate the themes and experiences tied to this gate and line. Their presence may encourage you to explore its influence and integrate its lessons into your journey.

Gate 51: The Arousing

The ability to respond to disorder and shock through recognition and adaptation.

Gate 51 represents a powerful force of willpower that responds to disorder and shock with a drive for recognition and adaptation. As part of the Centering Energy Family, it stands for individual initiative and a fierce competitive nature. This gate naturally tests itself, striving for competitive primacy and pushing boundaries to prove its strength. Its energy is bold and unpredictable, invoking actions that can either appear reckless or display great courage, as it ventures into situations where few dare to go. However, its effectiveness depends on trusting Inner Authority to temper its competitive spirit with wisdom, ensuring that courage does not lead to impulsiveness. Gate 51 commits its energy only when situations demand competitive willpower or the ability to respond to shock, avoiding unnecessary risks. When guided by the mind rather than Inner Authority, decisions influenced by this gate can lead to inconsistency and potentially harmful outcomes.

Gate 51 looks to connect with Gate 25 to form the Channel of Initiation, enabling a leap into pioneering exploration and new directions. This channel brings an unpredictable and electrifying energy that disrupts comfort zones, empowering others to find their center and broaden their perspectives. Its capacity to deliver shock and inspire change can lead to profound transformation, but its unpredictable nature also leaves it prone to melancholy when life lacks excitement or challenge. As the only individual gate in the Heart Center, Gate 51 carries a distinct energy of personal willpower and assertion, setting it apart from the tribal focus of the other gates. Its uniqueness lies in its ability to balance the disruptive power of shock with courage and wisdom, using its competitive drive to inspire and lead others into uncharted territory while staying aligned with its deeper purpose.

Additional Gate Information:

- Incarnation Crosses: Penetration, Shock, Clarion
- Incarnation Quarter: Mind (Initiation) - Aries
- Energy Circuit: Centering
- Amino Acid: Arginin
- Anatomy: Gall Bladder
- Gene Keys: Agitation (Cowardly / Hostile) - Initiative - Awakening



Line 3: Adaptation - Juxtaposed

↑ Sun: The life-sustaining awareness that thinks on its feet and thus creates opportunities. The power of spontaneity in times of challenge.

↓ Jupiter: The destabilization that occurs when one's field of normal activity is radically and unpredictably disturbed, where the tendency is withdrawal rather than adaptation. The ego that may be destabilized in times of challenge.

- Line Quality: Attuning and adapting to a trial and error process.

Line 3 in Gate 51 navigates shock through a natural trial and error process. This line's adaptability allows it to develop authentic wisdom about when to engage with or withdraw from challenging situations. Through direct experience, Line 3 discovers its true competitive nature, refining its approach with each encounter.

↑ Exaltation (Sun):

The Sun grants Line 3 a natural adaptability that thrives in chaos, enabling it to create opportunities through spontaneous responsiveness. For example, when faced with an unexpected crisis, Line 3 reflexively adjusts its approach, using its trial and error nature to find creative solutions. This ability to stay present and respond to the unique demands of each moment allows Line 3's competitive spirit to emerge authentically.

Through each engagement, Line 3 refines its capacity to react quickly and effectively. The Sun's influence enhances its ability to transform uncertainty into growth, building a foundation of wisdom and mastery. Its natural adaptability becomes a source of protection, helping it navigate shocks with creative resilience.

↓ Detriment (Jupiter):

Jupiter introduces a tendency for Line 3 to become destabilized when faced with extreme unpredictability. For instance, in situations where challenges radically deviate from familiar patterns, Line 3 may retreat instead of adapting. This withdrawal can prevent it from fully accessing its natural competitive spirit and creative problem-solving abilities.

When shock exceeds its current capacity for adaptation, Line 3's trial and error process may falter, leading to hesitation or avoidance. The key lies in its ability to differentiate between situations that require strategic retreat and those that call for creative engagement. By honoring both its need for safety and its capacity for spontaneous action, Line 3 develops the wisdom to handle even the most destabilizing circumstances.



Conscious Venus - Venus Return: Person

In this cycle, you will meet someone who embodies the qualities of Venus, through this gate and line. This individual will reflect the energy of harmony, beauty, and connection, offering a sense of balance and relationship within the channel they create with you. Their presence may feel magnetic, highlighting themes of love, values, and mutual appreciation.

Since this connection creates definition through a channel, their influence will help you explore the themes of this gate and line. They may encourage you to align with your values, nurture meaningful relationships, and integrate lessons of beauty and balance into your life.

Gate 51: The Arousing

The ability to respond to disorder and shock through recognition and adaptation.

Gate 51 represents a powerful force of willpower that responds to disorder and shock with a drive for recognition and adaptation. As part of the Centering Energy Family, it stands for individual initiative and a fierce competitive nature. This gate naturally tests itself, striving for competitive primacy and pushing boundaries to prove its strength. Its energy is bold and unpredictable, invoking actions that can either appear reckless or display great courage, as it ventures into situations where few dare to go. However, its effectiveness depends on trusting Inner Authority to temper its competitive spirit with wisdom, ensuring that courage does not lead to impulsiveness. Gate 51 commits its energy only when situations demand competitive willpower or the ability to respond to shock, avoiding unnecessary risks. When guided by the mind rather than Inner Authority, decisions influenced by this gate can lead to inconsistency and potentially harmful outcomes.

Gate 51 looks to connect with Gate 25 to form the Channel of Initiation, enabling a leap into pioneering exploration and new directions. This channel brings an unpredictable and electrifying energy that disrupts comfort zones, empowering others to find their center and broaden their perspectives. Its capacity to deliver shock and inspire change can lead to profound transformation, but its unpredictable nature also leaves it prone to melancholy when life lacks excitement or challenge. As the only individual gate in the Heart Center, Gate 51 carries a distinct energy of personal willpower and assertion, setting it apart from the tribal focus of the other gates. Its uniqueness lies in its ability to balance the disruptive power of shock with courage and wisdom, using its competitive drive to inspire and lead others into uncharted territory while staying aligned with its deeper purpose.

Additional Gate Information:

- Incarnation Crosses: Penetration, Shock, Clarion
- Incarnation Quarter: Mind (Initiation) - Aries
- Energy Circuit: Centering
- Amino Acid: Arginin
- Anatomy: Gall Bladder
- Gene Keys: Agitation (Cowardly / Hostile) - Initiative - Awakening



Line 3: Adaptation - Juxtaposed

↑ Sun: The life-sustaining awareness that thinks on its feet and thus creates opportunities. The power of spontaneity in times of challenge.

↓ Jupiter: The destabilization that occurs when one's field of normal activity is radically and unpredictably disturbed, where the tendency is withdrawal rather than adaptation. The ego that may be destabilized in times of challenge.

- Line Quality: Attuning and adapting to a trial and error process.

Line 3 in Gate 51 navigates shock through a natural trial and error process. This line's adaptability allows it to develop authentic wisdom about when to engage with or withdraw from challenging situations. Through direct experience, Line 3 discovers its true competitive nature, refining its approach with each encounter.

↑ Exaltation (Sun):

The Sun grants Line 3 a natural adaptability that thrives in chaos, enabling it to create opportunities through spontaneous responsiveness. For example, when faced with an unexpected crisis, Line 3 reflexively adjusts its approach, using its trial and error nature to find creative solutions. This ability to stay present and respond to the unique demands of each moment allows Line 3's competitive spirit to emerge authentically.

Through each engagement, Line 3 refines its capacity to react quickly and effectively. The Sun's influence enhances its ability to transform uncertainty into growth, building a foundation of wisdom and mastery. Its natural adaptability becomes a source of protection, helping it navigate shocks with creative resilience.

↓ Detriment (Jupiter):

Jupiter introduces a tendency for Line 3 to become destabilized when faced with extreme unpredictability. For instance, in situations where challenges radically deviate from familiar patterns, Line 3 may retreat instead of adapting. This withdrawal can prevent it from fully accessing its natural competitive spirit and creative problem-solving abilities.

When shock exceeds its current capacity for adaptation, Line 3's trial and error process may falter, leading to hesitation or avoidance. The key lies in its ability to differentiate between situations that require strategic retreat and those that call for creative engagement. By honoring both its need for safety and its capacity for spontaneous action, Line 3 develops the wisdom to handle even the most destabilizing circumstances.



Unconscious Neptune - Venus Return: Developmental

The Cycle Unconscious Neptune radiates as a field of fluid and veiling frequencies, influencing your form's profound relationship with hydration, moisture balance, and liquid rhythms. Through the gate and line it imprints, and by forming a channel with your foundational design, Neptune acts as a deeply rooted developmental force, shaping your body's capacity for circulation, absorption, and subtle fluid regulation. This influence operates beneath conscious awareness, guiding your form through patterns of flowing hydration and delicate balance. As the form's archetypal water bearer, Neptune aligns with the body's inherent ability to transform fluid distribution into life-sustaining essence, shifting between states of hydration and equilibrium as it moves through this cycle.

Neptune's developmental influence encourages your body to refine its capacity for fluid harmony, gradually evolving from simple hydration to an intricate balance of liquid rhythms. By forming a channel with your foundational design, this planetary force unconsciously strengthens your form's ability to maintain its moisture balance, shaping its vitality and subtle currents of sustenance. As the cycle progresses, your form will integrate Neptune's lessons of flow, hydration, and cellular harmony, responding instinctively to its aqueous and veiling frequencies.

Gate 25: Innocence

The perfection of action through on uncontrived and spontaneous nature.

Gate 25 embodies a profound capacity for universal, unconditional love that transcends individuals and encompasses all of existence. This "cool" and impersonal love reflects a deep compassion for life in its entirety, offering others a sense of self-acceptance simply by being in its presence. It carries the challenge of maintaining a state of unaffected innocence despite the trials and hardships of life. Each experience, no matter how difficult, has the potential to deepen this innate innocence and naturalness, reinforcing its connection to the sacredness of life. Mystical in nature, Gate 25 often resonates with the energy of a shaman or priestess, embodying an intuitive understanding of life's deeper, spiritual dimensions. Themes of blood, whether symbolic or literal, may recur in its experiences, as this gate represents "the blood within the vessel of love," tying it to the essence of vitality and connection.

This gate's universal love can sometimes be misunderstood, as its affection extends equally to all things, from a sunrise or a crystal to a person. Its unique perspective finds meaning in life's interconnectedness, transcending the apparent pointlessness of existence by embracing the sacred unity of all that is. Gate 25 serves as a vessel for universal love, radiating a profound sense of acceptance and unity to the world. Its energy naturally conditions others, inviting them to embrace themselves and life as it is. Through its deep compassion and spiritual clarity, Gate 25 brings an extraordinary sense of meaning and harmony to the human experience.

Additional Gate Information:

- Incarnation Crosses: Vessel of Love, Innocence, Healing
- Incarnation Quarter: Mind (Initiation) - Aries / Pisces
- Energy Circuit: Centering
- Amino Acid: Arginin
- Anatomy: Blood
- Gene Keys: Constriction (Ignorant-Cold) - Acceptance - Universal Love



Line 2: The Existentialist - No Fixing

Devotion and dedication to the now.

↑ **Mercury:** The perfection of the intellect through concentration and focus on what is, rather than, what could be or has been. The innocence of the Self and its protection can only be maintained in the now.

↓ **Mars:** A dedication that can never be free of personal motivation and its attendant projections. A lack of innocence in the now that risks protection through projection.
- Line Quality: Projection inwards. No subjective ability to see in. The natural.

The second line of Gate 25 embodies a natural state of pure existential presence, where love arises spontaneously through complete immersion in the now. This innate orientation to immediate experience creates a profound innocence, untainted by external projections or mental constructs. The second line's gift lies in its simple devotion to what is, allowing universal love to flow effortlessly without interference or self-consciousness.

↑ Exaltation (Mercury):

Mercury's influence highlights the second line's ability to derive intellectual clarity directly from pure presence rather than analysis. For example, by remaining fully immersed in the present moment, the second line experiences a deeper understanding that arises naturally, unclouded by the need to reach for answers or engage in mental construction. The wisdom revealed is a result of direct experience, leading to an organic connection to universal love.

This state of innocence protects the second line from the distortions of mental projection, creating a foundation where love and wisdom flow effortlessly. By staying anchored in the now, the second line demonstrates how understanding emerges not through intellectual effort, but through surrender to immediate experience.

↓ Detriment (Mars):

Mars introduces a challenge for the second line by exposing it to external recognition, which can disrupt its natural state and introduce self-consciousness. For instance, when others project motives or attempt to reward the second line's motiveless expression, its innocent presence can become clouded. This creates tension, as worldly expectations threaten to pull the second line away from its existential foundation.

This vulnerability to external projections can temporarily disconnect the second line from its natural flow of universal love. The paradox arises when others' recognition of the second line's purity inadvertently compromises it, making it difficult to maintain the profound simplicity of its authentic expression.



Activations of Channel 3041: Recognition

	P/D	Gate & Line	Fixing	Filter	Venus Return
Foundation	Personality	30.3	Exalted	Saturn	-
Venus	Personality	41.4	None	Pluto	Developmental
Venus	Design	41.1	None	Pluto	Developmental

Channel 3041: Recognition

A Design of Focused Feeling Energy.

The 3041 Channel, known as the Channel of Recognition, is deeply connected to the exploration of fantasy, emotions, and desires. It is not about forcing fantasies into reality or expecting desires to bring lasting peace. Instead, it is about feeling, living, and breathing these experiences—not as something theoretical or purely imaginative, but as a deeply embodied process. By sharing its dreams and wishes, the 3041 Channel stirs profound emotions in others, even when its aspirations remain unrealized.

Connecting the Solar Plexus and Root centers, the 3041 Channel brings emotional pressure that can manifest as restlessness or even desperation, particularly when fantasies become warped or disconnected from reality. This pressure compels it to explore fantasies fully, allowing emotional depth and clarity to emerge. Through this exploration, the channel creates the potential for real, meaningful experiences to come through and be recognized.

Ultimately, the 3041 Channel’s power lies in discerning which desires lead to genuine experiences and which remain fleeting illusions. Its strength is not in achieving or living out every fantasy, but in the wisdom and emotional depth gained through the process. By fully embracing its feelings and imagination, it inspires others while offering insight into the beauty and complexity of human longing and recognition.

Components

Type: Projected Channel

Energy Circuit: Sensing (Abstract) – Sharing

Gate 30: Clinging Fire: Freedom recognized as an illusion and limitation accepted as a fate. Quarter of Initiation.

Gate 41: Decrease: The limitation of resources which maximizes development of potential. Quarter of Mutation.



Foundation

Foundation Filter: Saturn

Like a wise elder holding the keys to mastery, Saturn represents our conscious approach to discipline and constraint. This grounding force shapes our relationship with authority, boundaries, and structure, conducting our ambitions through a matrix of patience, duty, and earned wisdom. As the archetypal guardian of time and material reality, Saturn pulses with measured growth, practical achievement, and the profound ability to transform limitation into excellence. Its energy manifests as both restrictive and strengthening - from the tests that build resilience to the structures that secure our destiny. Through Saturn, we learn to embrace necessary constraints, transforming fear into disciplined mastery, gradually evolving from inhibition to earned authority as we develop responsibility. As a personality activation Saturn represents "The Constraint" through the Alpha Vertical, The Mind Lateral and the Martial Diagonals.

Gate 30: The Clinging Fire

Freedom recognized as an illusion and limitation accepted as a fate.

Gate 30 embodies a profound capacity for feelings, desire, and longing, forming the emotional foundation of life's experiences. As part of the Abstract Sensing Circuit, it is driven by a hunger for new experiences, even when it doesn't fully understand what it longs for. This gate's primary challenge lies in managing its desires with emotional clarity and patience, avoiding impulsiveness or becoming overwhelmed by unfulfilled expectations. Approaching new experiences with a sense of 'coolness' and emotional balance allows Gate 30 to navigate life without taking outcomes personally. While initial desires or mental expectations often don't align with actual results, this gate thrives when it embraces the unexpected twists of life, known as the 'Fates,' which lead to discovery and growth. Wisdom emerges when Gate 30 learns to honor the journey itself, rather than fixating on achieving specific outcomes.

Deeply connected to the energy of desire and emotional intensity, Gate 30 reflects the raw and transformative power of feelings. Its emotional depth allows it to use feelings as a compass, guiding it through life's rich tapestry of experiences. Without emotional clarity, its constant longing can feel overwhelming, but when aligned with Inner Authority, Gate 30 navigates its emotional landscape with grace and resilience. Its true gift lies in its ability to feel deeply and authentically, inspiring others to embrace the unpredictability of life. By honoring its desires without attachment to specific results, Gate 30 transforms its emotional hunger into a source of empowerment and fulfillment, finding meaning in the ever-changing flow of experience.

Additional Gate Information:

- Incarnation Crosses: Contagion, Fates, Industry
- Incarnation Quarter: Mind (Initiation) - Aquarius
- Energy Circuit: Sensing (Abstract)
- Amino Acid: Glutamin
- Anatomy: Solar Plexus
- Gene Keys: Desire (Over-serious-Flippant) - Lightness - Rapture



Line 3: Resignation - Exalted

The acceptance of what is.

↑ **Pluto:** Not Active (Activated from 2040.03.28) - The awareness and manifestation of the law of regeneration. The laws of Karma, reincarnation and resurrection. The feeling to accept what is.

- Line Quality: Attuning and adapting to a trial and error process.

The third line of Gate 30 navigates the waves of emotional desire through a trial and error process that leads to a deep recognition—not of how to change what is, but how to fully accept it. This adaptation comes through lived emotional experiences rather than theoretical understanding, turning emotional cycles into profound lessons.

↑ **Exaltation (Pluto):**

With Pluto in exaltation, the third line uncovers the deeper patterns within emotional waves through its repeated trial and error process. For example, it may experience the highs and lows of a long-term relationship, eventually recognizing that growth comes not from forcing change but from embracing the natural flow of connection and separation. This process reveals how emotional cycles contain seeds of regeneration, teaching the third line about life's inherent rhythm of death and rebirth.

As this recognition deepens, the third line learns to flow with, rather than against, life's emotional currents. Its adaptability becomes a gateway to spiritual understanding, showing others that true transformation emerges through acceptance. By surrendering to the natural rhythm of emotions, the third line embodies a wisdom that reveals emotional clarity comes not from control, but from trust in life's unfolding.



Venus Return

Conscious Pluto - Venus Return: Developmental

The Cycle Pluto radiates as a conscious field of transformative frequencies, influencing your personality's relationship with power, renewal, and cycles of change through the gate and line it imprints. By forming a channel with your foundational design, this Plutonian activation acts as a developmental force, inviting your mind to consciously engage with life's deeper layers and confront hidden truths. Pluto's energy works by unearthing what has been buried, revealing profound truths through the gate and line it activates. These truths often emerge through transformative experiences, challenging your personality to consciously embrace change and growth.

Pluto's developmental influence encourages you to navigate the cycles of creation and destruction with courage, allowing the revealed truths to guide your journey of empowerment and renewal. Through the gate and line it activates, Pluto's energy facilitates the evolution of your personality, uncovering hidden depths and latent strength. As the cycle unfolds, you will consciously engage with Pluto's transformative power, integrating its revelations into your personality. This process allows you to realign with your core essence, fostering resilience and a deeper understanding of your authentic self.

Gate 41: Decrease

The limitation of resources which maximizes development of potential.

Gate 41 embodies the energy of contraction and serves as the fuel for human experience. It carries a pressure to seek experiences through feelings, using its powerful imagination to envision endless possibilities. As a gate of contraction, it functions like a compressed spring, holding immense potential energy that launches new experiences upon release. Gate 41 represents the starting point for all human processes and experiences, fueling the drive to imagine and initiate something new. Its challenge lies in focusing on a single feeling or fantasy, resisting the pull of overwhelm caused by too many possibilities. This energy is restless, sensing the need for new beginnings but often lacking clarity without the support of Gate 30, which provides a sense of specific desires or changes. Together, Gates 41 and 30 form the channel of feeling recognition, but in the absence of Gate 30, this clarity may come through interactions with others with the 30 or planetary transits.

As the sole start codon in Human Design, Gate 41 plays a critical role in initiating all new experiences, representing a powerful evolutionary force. Its desire for feelings and its capacity for fantasy are the wellspring from which human experiences emerge. However, this energy must be balanced to avoid scattering its focus, ensuring that its imaginative potential is channeled toward meaningful exploration. Gate 41 thrives when it embraces its role as an initiator, grounding its visions in focused action while maintaining its connection to the limitless possibilities of imagination. By honoring its need for balance and clarity, Gate 41 fulfills its essential role in sparking new beginnings and fueling the evolution of human experience.

Additional Gate Information:

- Incarnation Crosses: The Unexpected, Fantasy, Alpha
- Energy Circuit: Sensing (Abstract)
- Incarnation Quarter: Spirit (Mutation) - Aquarius
- Amino Acid: Methionin (Initiator Codon)
- Anatomy: Adrenals
- Gene Keys: Fantasy (Dreamy/Hyperactive) - Anticipation - Emanation



Line 4: Correction - No Fixing

Successful adaptation to limitation.

↑ **Earth:** Survival of the fittest and its eventual flourishing. The energy for adaptation and a deep feeling for survival.

↓ **Venus:** The expenditure of energy on maintaining relationships rather than on correction. In times of decrease weak associations are shunned as costly, no matter how attractive. The energy which fuels holding on to feelings rather than adapt.

- Line Quality: Fixed on externalizing its single track quality.

Line 4 carries a fixedness in wanting to live out its experiential fantasy. As a fourth line, it naturally influences others, particularly those carrying the emotional fire of the 30, to recognize and align with its feelings. This unchanging focus becomes the foundation of its power and influence.

↑ Exaltation (Earth):

The Earth grants Line 4 a unidirectional focus that ensures success through persistence. For example, Line 4 may remain dedicated to a lifelong passion or project, refusing to deviate from its chosen course despite challenges or distractions. This unwavering commitment to one feeling or fantasy builds momentum over time, allowing Line 4 to flourish in ways others may not fully understand.

Line 4's attunement to timing, supported by the Earth's patience, ensures that it waits for the right moment to externalize its feelings. This constancy and alignment with cycles enable Line 4 to naturally attract the right people and opportunities, amplifying its influence and reinforcing its fixed direction.

↓ Detriment (Venus):

Under the Venusian detriment, Line 4 struggles with the pressure to maintain relationships, which pulls it away from its fixed direction. For example, Line 4 may begin to accommodate the needs or expectations of others, diluting its focus and compromising its natural state. This attempt to bridge different approaches splits its energy, leaving it unable to fully commit to its original path.

Over time, these small accommodations grow into significant diversions from Line 4's intended course. The frustration of never fully expressing its fixed fantasy builds steadily, as the gap between its potential and lived experience widens. Each compromise to please others further buries its natural direction, creating a lingering sense of dissatisfaction and unfulfilled potential.



Unconscious Pluto - Venus Return: Developmental

The Cycle Unconscious Pluto radiates as a field of penetrating and regenerative frequencies, influencing your form's deepest relationship with breath, environmental absorption, and vital exchange. Through the gate and line it imprints, and by forming a channel with your foundational design, Pluto acts as a deeply rooted developmental force, shaping your body's capacity for transformation, assimilation, and the intake of life force. This influence operates beneath conscious awareness, guiding your form through cycles of inhalation, renewal, and environmental interaction. As the form's archetypal breath master, Pluto aligns with the body's inherent ability to transform atmospheric elements into life-sustaining power, shifting between states of absorption and release as it moves through this cycle.

Pluto's developmental influence encourages your body to refine its capacity for vital exchange, gradually evolving from basic intake to a regenerative rhythm of assimilation and release. By forming a channel with your foundational design, this planetary force unconsciously strengthens your form's ability to sustain its essential respiratory patterns, shaping its resilience and connection to environmental energy. As the cycle progresses, your form will integrate Pluto's lessons of transformation, renewal, and breath mastery, responding instinctively to its penetrating and life-sustaining frequencies.

Gate 41: Decrease

The limitation of resources which maximizes development of potential.

Gate 41 embodies the energy of contraction and serves as the fuel for human experience. It carries a pressure to seek experiences through feelings, using its powerful imagination to envision endless possibilities. As a gate of contraction, it functions like a compressed spring, holding immense potential energy that launches new experiences upon release. Gate 41 represents the starting point for all human processes and experiences, fueling the drive to imagine and initiate something new. Its challenge lies in focusing on a single feeling or fantasy, resisting the pull of overwhelm caused by too many possibilities. This energy is restless, sensing the need for new beginnings but often lacking clarity without the support of Gate 30, which provides a sense of specific desires or changes. Together, Gates 41 and 30 form the channel of feeling recognition, but in the absence of Gate 30, this clarity may come through interactions with others with the 30 or planetary transits.

As the sole start codon in Human Design, Gate 41 plays a critical role in initiating all new experiences, representing a powerful evolutionary force. Its desire for feelings and its capacity for fantasy are the wellspring from which human experiences emerge. However, this energy must be balanced to avoid scattering its focus, ensuring that its imaginative potential is channeled toward meaningful exploration. Gate 41 thrives when it embraces its role as an initiator, grounding its visions in focused action while maintaining its connection to the limitless possibilities of imagination. By honoring its need for balance and clarity, Gate 41 fulfills its essential role in sparking new beginnings and fueling the evolution of human experience.

Additional Gate Information:

- Incarnation Crosses: The Unexpected, Fantasy, Alpha
- Energy Circuit: Sensing (Abstract)
- Incarnation Quarter: Spirit (Mutation) - Aquarius
- Amino Acid: Methionin (Initiator Codon)
- Anatomy: Adrenals
- Gene Keys: Fantasy (Dreamy/Hyperactive) - Anticipation - Emanation



Line 1: Reasonableness - No Fixing

The appropriate delegation of responsibility.

↑ **Neptune:** The imagination to make the very best out of very little. Coolness, where the energy to release feelings is selective.

↓ **Mercury:** A tendency in understanding, to assume capability, leading to strain. The hothead, the urge to release feelings.

- Line Quality: Introspective and investigating.

Line 1 embodies the foundational power of focused imagination, rooted in its introspective nature. This focus demands selective attention to single feelings, avoiding the dispersion of energy across multiple experiences or fantasies. By concentrating on one feeling at a time, Line 1 creates a foundation for meaningful exploration and sustained creativity.

↑ Exaltation (Neptune):

Neptune grants Line 1 an extraordinary ability to extract maximum value from minimal input. Like an artist who uses only a few colors to create masterpieces, Line 1's focused imagination becomes a precision tool for deeply exploring single fantasies. For example, Line 1 might immerse itself fully in a single creative idea, achieving profound insights and results without scattering its energy across multiple pursuits. This natural coolness and selective release of feelings prevent emotional or energetic dispersion, allowing for sustained and controlled exploration.

Neptune's influence also enhances Line 1's understanding that limitation breeds creativity. By channeling its energy into one focused feeling, Line 1 unlocks deeper realms of possibility and imagination. This innate relationship with resource management ensures that Line 1 maximizes minimal input for optimal output, creating a natural efficiency in its exploration of fantasy and feeling.

↓ Detriment (Mercury):

Under Mercury's detriment, Line 1 struggles with a tendency to overestimate its capacity, leading to strain and unsustainable efforts. For example, Line 1 might attempt to pursue multiple fantasies simultaneously, dispersing its energy and disrupting its natural focus. This scattering of attention opposes its introspective nature, leaving it overwhelmed and ineffective.

Mercury's influence can also create a crisis when Line 1 tries to live out fantasies beyond its resources or capacity. Instead of investigating the feeling itself, as it is naturally designed to do, Line 1 may push to externally manifest every idea, resulting in stress and failure. True understanding for Line 1 comes through accepting its role as the starting point of human experience, focused on deeply comprehending the nature of imagination rather than manifesting every fantasy.



Activations of Channel 1949: Synthesis

	P/D	Gate & Line	Fixing	Filter	Venus Return
Foundation	Personality	49.4	None	Mercury	-
Venus	Design	19.2	Detriment	Moon	Person

Channel 1949: Synthesis

A Design of Sensitivity.

The 1949 Channel, known as the Channel of Synthesis, is deeply attuned to managing resources and fostering fairness within its community. As part of the Tribal Circuit, this channel is designed to ensure the survival and well-being of the group by balancing practicality with sensitivity. Its gift lies in providing service to others while creating harmonious relationships built on fairness and mutual support. Emotional clarity is essential for the 1949 Channel, as it thrives when it takes the time to let relationships and commitments unfold naturally.

This channel's sensitivity is closely tied to its role in managing resources and ensuring the community's needs are met. It is deeply connected to the physical world, particularly through food, as sharing meals is a vital way for it to build trust and strengthen bonds. The 1949 Channel also has a unique awareness of how resources, both emotional and material, are distributed within its relationships and surroundings. This sense of service and responsibility makes it a natural provider and protector for its tribe, but it must remember to honor its own emotional needs in the process.

The primary challenge for the 1949 Channel is balancing its strong sense of responsibility to others with staying true to its own principles and boundaries. Its sensitivity acts as a powerful compass, guiding it toward decisions and relationships that align with fairness and sustainability. By embracing its role as a steward of resources and a provider of service, while respecting its emotional rhythms, the 1949 Channel fulfills its purpose as a unifier and nurturer within the collective.

Components

Channel Type: Projected

Energy Family: Tribal - Support

Gate 19: Approach: That all things are interrelated is apparent and manifested through the action of approach. Quarter of Mutation.

Gate 49: Revolution: Ideally the transformation of forms based on the highest principles and not simply for power. Quarter of Initiation.



Foundation

Foundation Filter: Mercury

Like a nimble messenger weaving through neural pathways, Mercury represents our conscious communication style, orchestrating how we express and exchange ideas through speech, writing, and thought. This mercurial force shapes our intellectual patterns and verbal expressions, conducting our perceptions through an intricate network of logic, wit, and intuitive connections. As the archetypal trickster and communicator, Mercury pulses with mental agility, nervous system flexibility, and the profound ability to translate knowledge into expression. Its energy manifests as both clever and connective - from the quick commerce of information to the carefully crafted reasoning that bridges minds. Through Mercury, we learn to articulate our thoughts, transforming raw mental activity into eloquent communication, gradually evolving from youthful chatter to meaningful exchange as we develop rational clarity. As a personality activation Mercury controls Communication through the Voice Lateral and Outer Authority Vertical.

Gate 49: Revolution

Ideally the transformation of forms based on the highest principles and not simply for power.

Gate 49 represents a profound connection to the emotional systems that govern tribal resources and relationships. It operates through Tribal ratchet/fast release emotional waves, which influence the perception of needs and principles over time. This gate plays a critical role in establishing principles for resource distribution, determining how and why resources are allocated within the tribe. Its sensitivity to the emotional climate allows it to sense when change or even revolution is necessary, but this same sensitivity requires careful awareness of emotional fluctuations to avoid hasty rejections or decisions. Gate 49's strength lies in its ability to discriminate and organize tribal resources effectively, ensuring the survival and well-being of the community. However, its principles are closely tied to its emotional states, creating moments of acceptance or rejection that can shift depending on where it is within its emotional wave.

To maintain its effectiveness, Gate 49 must prioritize clear and constant communication, as its principles and perceptions are subject to change with the natural rise and fall of emotions. It holds the power of exclusion, but this power is most effective when used as a last resort rather than a reaction to fleeting emotional states. When perceived as unprincipled or not serving the tribal good, Gate 49 risks rejection, emphasizing the importance of emotional clarity before taking action. Its fluctuating awareness of need and principle means it may view situations differently at emotional peaks versus valleys, requiring patience and restraint to ensure sound judgment. By adhering to the mantra "Stay in communication and don't act in the moment," Gate 49 can navigate its emotional waves with wisdom, ensuring its decisions serve the tribal good and uphold the principles that sustain tribal survival.

Additional Gate Information:

- Incarnation Crosses: Explanation, Principles, Revolution
- Incarnation Quarter: Mind (Initiation) - Aquarius
- Energy Circuit: Tribal
- Amino Acid: Histidin
- Anatomy: Solar Plexus
- Gene Keys: Reaction (Inert-Rejecting) - Revolution - Rebirth



Line 4: Platform - No Fixing

↑ Jupiter: A political and social agenda, embodied in guarantees to human rights that ensures a just and valued replacement of the old order. A potential sensitivity to the needs of society.

↓ Mars: Promises, promises, promises and only to guarantee support with little possibility of implementation. A potential to insensitively take advantage of the needs of society.

- Line Quality: Fixed on externalizing its single track quality.

As a fourth line in this gate of principles and revolution, Line 4 carries a singular, narrow focus—a fixed agenda that it deems essential for the tribe’s wellbeing. Line 4 is not concerned with broad societal change or multiple causes; instead, it champions one specific mission with unwavering dedication. Whether seen as a steadfast advocate or an inflexible zealot, Line 4 remains fixed in its position, prioritizing principle over perception.

↑ Exaltation (Jupiter):

Jupiter supports Line 4’s ability to identify the one critical issue it believes must be addressed. For example, Line 4 might focus solely on animal welfare, viewing it as the key change needed for the tribe’s evolution. This fixed focus allows Line 4 to channel its energy into recognizing and pursuing solutions that others might overlook.

Line 4’s single-minded dedication becomes a powerful strength when its platform aligns with genuine tribal needs. While others may spread their efforts across multiple causes, Line 4 remains steadfast, offering clarity and consistency. This unwavering focus enables Line 4 to create meaningful change by refusing to dilute its message, becoming a catalyst for progress.

↓ Detriment (Mars):

Mars can turn Line 4’s singular focus into a form of blindness, where it fixates on its platform to the exclusion of all else. For instance, Line 4 might make sweeping promises about how its one solution will solve every issue, ignoring practical limitations or dismissing other valid tribal needs. This tunnel vision prevents Line 4 from seeing the broader context and risks alienating others.

As Line 4 continues to insist on its narrow agenda, its promises may become increasingly unrealistic. The inability to adapt or consider alternative perspectives isolates Line 4, undermining its revolutionary potential. Instead of inspiring support, its rigid approach creates division, leaving its cause—and its connection to the tribe—at risk of failure.



Venus Return

Unconscious Moon - Venus Return: Person

During this cycle, you may cross paths with someone who brings a unique focus to the gate and line imprinted by the Moon in your Cycle chart. They embody the Moon's flowing and receptive energy, naturally drawing attention to this aspect of your chart.

Since this connection creates definition through a channel, their emotional awareness and attunement will help illuminate the themes and experiences tied to this gate and line. Their presence may encourage you to explore its influence and integrate its lessons into your journey.

Gate 19: Approach

That all things are interrelated is apparent and manifested through the action of approach.

Gate 19 embodies the energy of Wanting and Needing, serving as a cornerstone of the Tribal Energy Family by creating pressure to secure and manage resources essential for the tribe's survival. It functions as an early warning system, recognizing potential resource scarcity that could threaten tribal cohesion and stability. This gate is deeply attuned to ensuring the tribe's basic needs—food, shelter, and spirituality—are met. Its energy is balanced by Gate 49, which determines how resources are allocated based on principles and agreements. Together, they form the mystical 19/49 channel, emphasizing both the spiritual and practical aspects of resource management. Gate 19 also carries a unique sensitivity, strengthening bonds within the tribe through touch and an innate connection to mammals, reflecting its cross-species nature. This gate's role is both practical and spiritual, ensuring not only survival but also fostering deeper connections within the tribe.

The challenge of Gate 19 lies in balancing the drive to secure resources with maintaining harmonious relationships within the tribe. Its energy explores possibilities through interaction and flirtation, but clear agreements—especially in conjunction with Gate 49—are essential for fulfilling the tribe's needs effectively. Without sufficient resources, the tribe risks disbandment, underscoring the critical role Gate 19 plays in preserving the strength and unity of the group. This gate's influence plays a key role in maintaining the physical health and stability of the tribe, which indirectly supports emotional well-being by ensuring that basic needs—such as resources, connection, and security—are met. While Gate 19 is rooted in the pressure of the Root Center, it works in harmony with other gates, including those in the Solar Plexus Center, to foster a sense of safety and belonging, which contributes to the emotional resilience of the tribe.

Additional Gate Information:

- Incarnation Crosses: Four Ways, Need, Refinement
- Incarnation Quarter: Spirit (Mutation) - Aquarius
- Energy Circuit: Tribal
- Amino Acid: Isoleucin
- Anatomy: Body Hair
- Gene Keys: Co-dependence (Needy-Isolated) - Sensitivity - Sacrifice



Line 2: Service - Detriment

The dedication of personal resources as a result of external contact.

↓ **Mercury:** Protracted indecision, but given the nature of this position, eventual compliance. The need to be wanted that will eventually turn its energy to service.
- Line Quality: Projection inwards. No subjective ability to see in. The natural.

The second line of Gate 19 expresses its dedication to service through natural projection, drawing others to recognize its potential for contribution before the line itself is fully conscious of it. This inward projection creates a magnetic pull that attracts opportunities for meaningful exchanges of resources and service, forming the foundation for its role within the tribe.

↓ **Detriment (Mercury):**

This line's Mercury detriment can lead to initial resistance to service roles. For instance, its natural projection may attract multiple opportunities, but an internal tendency to overthink or analyze their implications stalls its engagement. This hesitation creates a period of uncertainty before the line fully commits to its role.

Mercury's influence can also manifest as a negotiation between the desire for resources and the obligations of service. While the line continues to draw opportunities for contribution, its internal resistance must be resolved before it can embrace its natural role within the tribe, creating occasional delays in fulfilling its potential.



Educational Channels

An Educational Channel is created when two or more gates from your Venus Return Cycle come together. Since these gates are not part of your Foundation Design, the channel takes on an educational quality. This channel may also link two undefined centers in your design, which can further enhance its educational impact. Educational Channels may present themselves as opportunities for **developmental** growth, new **directional** movements, or lessons through your interactions with two or more individuals you encounter.

Channel 1762: Acceptance	Developmental
Channel 0515: Rhythm	Person, Experiential



Activations of Channel 1762: Acceptance

	P/D	Gate & Line	Fixing	Filter	Venus Return
Venus	Personality	17.1	None	Saturn	Developmental
Venus	Design	62.2	Exalted	Jupiter	Developmental

Channel 1762: Acceptance

A Design of an Organizational Being.

The 1762 Channel, known as the Channel of Acceptance, possesses a rare mental gift for seeing the big picture without losing sight of the details. However, its long-term visions thrive only when supported by a solid foundation of factual information. This channel excels at gathering and organizing relevant data, ensuring that its insights and opinions are well-informed and impactful. Its ability to recognize and refine logical patterns makes it a natural organizer and a forward-thinking problem-solver.

When invited to share, the 1762 Channel captivates others with its detailed knowledge and practical insights. However, as a projected channel, it must wait for the right invitation to share its perspective effectively. Speaking without an invitation risks overwhelming others with unnecessary details, which can dilute its clarity and hinder its ability to see patterns clearly. This channel's true strength lies in responding to invitations where its logical thinking and organizational talents are valued.

The visually-oriented nature of the 1762 Channel enables it to analyze structures, identify flaws, and propose improvements with precision. Its logical and managerial skills make it a highly sought-after contributor in collective settings. By patiently waiting for invitations to share its insights, the channel maximizes its impact as a visionary and a problem-solver for the future. Embracing its role as a builder of logical systems, the channel fulfills its purpose of enhancing efficiency and improving the collective.

Components

Channel Type: Projected

Energy Family: Understanding (Logical) – Sharing

Gate 17: Following: The ancient law that those who wish to rule must know how to serve. Quarter of Initiation.

Gate 62: Preponderance of the Small: Caution, patience and detail produce excellence out of limitation. Quarter of Civilization.



Venus Return

Conscious Saturn - Venus Return: Developmental

The Cycle Saturn radiates as a conscious field of stabilizing frequencies, influencing your personality's relationship with discipline, structure, and responsibility through the gate and line it imprints. By forming a channel with your foundational design, this Saturnian activation serves as a deliberate developmental force, urging your mind to consciously engage with life's challenges. Saturn invites you to recognize the value of discipline and persistence, consciously aligning your mental focus with the creation of strong and enduring foundations for growth.

Saturn's developmental influence consciously encourages you to refine your systems and embrace accountability as a tool for mastery. Through the gate and line it activates, Saturn shapes your personality's ability to navigate limitations and transform them into opportunities for growth. As the cycle unfolds, you will consciously integrate lessons of patience, responsibility, and resilience, aligning your mind with Saturn's stabilizing frequencies. This process allows you to consciously build the structures necessary to support your long-term aspirations, fostering maturity and grounded progress.

Gate 17: Following

The ancient law that those who wish to rule must know how to serve.

Gate 17 represents a vital aspect of logical understanding through its ability to organize concepts and form opinions that serve the collective. This gate projects the mind into the future, seeking to create workable solutions and frameworks that provide value to others. It thrives on identifying logical patterns, structures, and frameworks, offering insight into how things can be improved or optimized over time. However, the opinions formed by Gate 17 remain theoretical until they are substantiated with the depth and detail provided by Gate 62. Without this articulation, the concepts may feel incomplete, though access to Gate 62 often becomes available at the right time through interactions with others or planetary transits. Patience is key, as opinions are best shared when recognized and invited, allowing Gate 17's insights to be expressed in a way that is impactful and well-received.

This gate also carries a unique relationship with time, as its mental projections often transcend conventional clock time and instead align with the "right time" for concepts to emerge and be shared. The organizing potential of Gate 17 is deeply forward-looking, offering valuable contributions to structuring the collective future. However, its energy must remain grounded in service, recognizing that its purpose is to benefit others rather than assert intellectual superiority. When expressed with humility and patience, the logical clarity and organizational abilities of Gate 17 become a powerful tool for collective progress, inspiring others to align with a more structured and thoughtful vision of the future.

Additional Gate Information:

- Incarnation Crosses: Service, Opinions, Upheaval
- Incarnation Quarter: Form (Civilization) - Gemini
- Energy Circuit: Understanding (Logical)
- Amino Acid: Arginin
- Anatomy: Pituitary Gland, Right Eye
- Gene Keys: Opinion (Self-critical-Opinionated) - Farsightedness-Omniscience



Line 1: Openness - No Fixing

↑ **Mars:** The energy to sustain a broad spectrum of stimuli. The possibility of having many opinions.

↓ **Venus:** A tendency to limit openness to aesthetically pleasing stimuli. The possibility to limit opinions to what is pleasing.

- Line Quality: Introspective and investigating.

The first line of Gate 17 establishes the foundational nature of how opinions form through direct investigation and personal experience. As an introspective first line, it begins the process of developing opinions with deep internal examination of stimuli. This creates the base from which all other levels of opinions in this gate emerge, setting the tone for how organized views are formed and expressed.

↑ Exaltation (Mars)

This line's Mars exaltation manifests as remarkable stamina for processing and engaging with a vast spectrum of stimuli. For example, the line's ability to sustain attention across diverse topics ensures it builds a rich internal database of experiences. This investigative quality supports the continuous formation of opinions, providing a solid foundation for the gate's organizing principle.

The Mars influence enables this line to remain open to new stimuli, maintaining tireless mental energy for firsthand investigation. This ensures that its opinions emerge naturally from direct experience rather than adopting beliefs from others. Its martial endurance creates a comprehensive framework of personal views that support the gate's purpose.

↓ Detriment (Venus)

This line's Venus detriment manifests as a tendency to limit natural openness by focusing only on what feels aesthetically pleasing or harmonious. For instance, this line may investigate deeply within areas that appeal to its sense of beauty while dismissing or ignoring less attractive but equally important subjects. This selective approach creates an imbalance in the gate's full potential for opinion formation.

The Venusian influence can make this line resistant to exploring challenging or uncomfortable topics. While it may develop sophisticated views within its preferred domains, this narrow focus prevents it from building a comprehensive understanding. Instead of maintaining openness to all stimuli, the investigative process becomes too selective, limiting the foundational role of this line.



Unconscious Jupiter - Venus Return: Developmental

The Cycle Design Jupiter radiates as an unconscious field of protective frequencies, influencing your form's relationship with rules, laws, and security systems through the gate and line it imprints. By forming a channel with your foundational design, this Jupiterian imprint acts as a deeply rooted developmental force, conditioning your body directly. Operating beneath conscious awareness, this influence shapes your form's ability to establish stability, abundance, and resilience. While unconscious, this energy aligns with the natural rhythms of your form, refining its innate security systems as it moves through this cycle.

Jupiter's developmental influence encourages your body to transform raw potential into a more balanced and secure state of being. Through the gate and line it activates, this planetary force unconsciously supports the evolution of your form, guiding it toward greater stability and measured abundance. As the cycle progresses, your form will naturally integrate lessons of expansion, protection, and wisdom, responding instinctively to Jupiter's expansive and protective frequencies. This unconscious process allows your form to grow into its inherent capacity for resilience and prosperity, gradually strengthening its foundation without the need for conscious intervention.

Gate 62: Preponderance of the Small

Caution, patience and detail produce excellence out of limitation.

Gate 62 embodies the power of communication within the Logical Understanding family, organizing mental patterns into clear, factual, and detailed language. Its nature precisely names and describes by organizing facts, translating complex concepts into accessible terms while avoiding premature information sharing. The challenge of Gate 62 lies in patiently assembling details to create robust frameworks for understanding. Its effectiveness requires recognizing that presenting facts does not necessarily equate to correctness. This gate serves as the voice of the logical mind, expressing itself through "I think" assertions rather than initiating action. Its validation depends on experiential proof that goes beyond mental processing, ensuring that its observations and facts hold true in practice.

The strength of Gate 62 lies in projecting logical patterns forward while noticing even the smallest details. Its power extends to the capacity for cross-species communication, contributing to collective understanding through the articulation of clear and organized details. Effectiveness emerges through careful observation and adherence to facts, avoiding assumptions about patterns. The accuracy of this gate depends on patience and thorough examination rather than jumping to immediate conclusions. By sharing organized information rather than making unsupported assumptions, Gate 62 serves as a powerful force for clarity, contributing to the collective progress of logical understanding.

Additional Gate Information:

- Incarnation Crosses: Maya, Detail, Obscuration
- Incarnation Quarter: Form (Civilization) - Cancer
- Energy Circuit: Logical
- Amino Acid: Tyrosin
- Anatomy: Throat / Thyroid
- Gene Keys: Intellect (Obsessive/Pedantic) - Precision - Impeccability



Line 2: Restraint - Exalted

↑ **Saturn:** The innate restrictiveness and discipline to comply with and exalt restraint. The discipline necessary for detail work.

- Line Quality: Projection inwards. No subjective ability to see in. The natural.

Line 2 in Gate 62 creates a unique dynamic in the realm of detailed communication, projecting an image of disciplined focus and methodical investigation. This natural projection can lead to both opportunities and challenges in how it processes and shares logical information with others.

↑ **Exaltation (Saturn):**

With Saturn exalted, Line 2 projects an aura of disciplined dedication to detail work. For example, its Saturnian influence creates an outward appearance of methodical focus and systematic investigation that inspires trust from others. This projection often draws people seeking careful logical analysis, even when Line 2's actual process may still be unfolding internally.

Saturn's structured energy allows Line 2 to maintain a composed and focused demeanor, even when working with complex details. This projected restraint not only creates beneficial spaces for logical exploration but also inspires others to approach their work with greater discipline, amplifying the value of logical processes.



Activations of Channel 0515: Rhythm

	P/D	Gate & Line	Fixing	Filter	Venus Return
Venus	Design	5.5	None	Mercury	Person
Venus	Design	15.4	None	Earth	Experiential

Channel 0515: Rhythm

A Design of Being in the flow.

The 0515 Channel, known as the Channel of Rhythm, embodies the fundamental rhythm of life—a pattern that exists at the cellular level of all living things. This channel connects the G Center (Identity) to the Sacral Center through Gate 15 (Extremes) and Gate 5 (Fixed Rhythm), making it a natural timekeeper of life's flow. Its magnetic aura naturally draws others into its rhythm, and when aligned with its own natural flow, everything moves effortlessly.

The 0515 Channel's challenge and gift lie in surrendering to its natural flow rather than resisting it. It is designed to trust the timing of inner authority rather than allowing the mind to disrupt its rhythm. When functioning correctly, it embodies the love of humanity (Gate 15) while maintaining consistent patterns (Gate 5). This channel instinctively adjusts its rhythm to meet changing circumstances while staying grounded in its core tempo, creating a unique dynamic in relationships where harmony between fixed and changing rhythms is essential.

The 0515 Channel operates best when it moves through life's patterns guided by inner authority, rather than following external expectations. Its natural rhythm emerges when it stops trying to control life and instead responds to it as it unfolds. As one of the foundations of life's flow, this channel cannot fulfill its purpose if it fights against the current. Its role is not to create the world but to respond to it in alignment with its design, allowing its rhythm to guide it through life's ever-changing patterns.

Components

Channel Type: Generated

Energy Family: Understanding - Sharing

Gate 5: Waiting: The fundamental attunement to natural rhythms. Waiting as an active state of awareness. Quarter of Mutation.

Gate 15: Modesty: The quality of behavior which expresses the proper balance between extremes. Quarter of Civilization.



Venus Return

Unconscious Mercury - Venus Return: Person

During this cycle, you may encounter someone who subtly embodies the unconscious energy of Mercury, bringing the themes of the gate and line they carry into your life. Their influence might not be immediately obvious, but through your interactions, you could notice shifts in how you process and exchange ideas.

This activation creates definition in your design and has the potential to stimulate deeper thought patterns or provoke insights that emerge unexpectedly, often beyond conscious awareness. If you choose to engage, their presence may inspire you, offering opportunities for subtle yet profound growth in how you communicate and connect with others.

Gate 5: Waiting

The fundamental attunement to natural rhythms. Waiting as an active state of awareness.

Gate 5 represents the adherence to fixed rhythms and patterns, embodying a deep attunement to natural cycles and the universal flow of life. It emphasizes the importance of recognizing and aligning with personal rhythms, offering the ability to establish habits and routines that provide security, stability, and efficiency. This energy plays a significant role in skill development, thriving through repetition and the consistent practice necessary to achieve mastery. While Gate 5 finds strength in its unwavering consistency, it can sometimes feel constrained by its fixed rhythms. The key to its transcendence lies in patiently waiting for life to naturally shift its flow, rather than forcing change or succumbing to external pressures.

The challenge of Gate 5 is in identifying and honoring its innate rhythms while resisting the conditioning of others or mental pressures that attempt to disrupt its natural patterns. Transforming these rhythms into intentional habits allows this energy to operate in harmony with the larger collective flow. By staying true to its inner timing, Gate 5 creates a stable foundation upon which progress, understanding, and mastery can flourish. When properly aligned, this energy not only fosters personal growth but also contributes to the greater good, offering the potential for profound stability and even transcendence within life's ever-evolving patterns.

Additional Gate Information:

- Incarnation Crosses: Consciousness, Habits, Separation
- Incarnation Quarter: Spirit (Mutation) - Sagittarius
- Energy Circuit: Understanding (Logical)
- Amino Acid: Threonin
- Anatomy: Sacral Plexus
- Gene Keys: Impatience (Pessimistic-Pushy) - Patience - Timelessness



Line 5: Joy - No Fixing

Waiting as an aspect of enlightenment.

↑ **Venus:** To remain calm as the ultimate aesthetic and thus recognize the inner meaning of being. The power to be calm and to find one's place in the flow.

↓ **Pluto:** Joy dismissed as an illusion. waiting as a failure. Disillusionment with recognizing one's place in the flow.

- Line Quality: Completes and universalizes the theme of the Hexagram.

The fifth line position brings forth a natural serenity that flows from honoring inherent rhythms, creating a presence that others perceive as deep wisdom or enlightenment. While this allows waiting to become an art form of profound presence, it can create deep disillusionment with projected expectations of mastery, leading to internal conflict between maintaining appearances and honoring authentic experience.

↑ Exaltation (Venus):

Venus exalted brings the gift of genuine calm as the ultimate aesthetic expression. Like a still pond that naturally reflects the sky, this fifth line position manifests as embodied serenity that others interpret as enlightenment. Through Venus's influence emerges the power to remain genuinely still within fixed rhythms, regardless of external circumstances.

This creates a natural reflection of inner alignment. Like a master artist whose simplest gestures carry profound beauty, this positioning enables waiting to become an art form of pure presence, transforming natural rhythm into a mirror that reflects others' aspirations toward enlightenment.

↓ Detriment (Pluto):

Under Pluto's detriment influence, projected expectations create internal pressure. This Plutonian energy becomes distorted into a painful disconnect between external perceptions and internal reality. Like an artist burdened by others' interpretations of their work, what begins as natural serenity becomes transformed into performance.

This detriment often appears as struggle between authentic experience and maintaining appearances. The potential for genuine presence becomes transformed into doubt and disillusionment, resulting in viewing joy itself as illusion rather than finding authenticity within the projection field.



Unconscious Earth - Venus Return: Experiential

During this cycle, the Unconscious Earth anchors the physical form, shaping the foundation of the body's stability and instinctual grounding. Acting as a steadying force, it supports the natural rhythms of balance, rootedness, and embodied intelligence. The Earth's energy pulses through the cycle, guiding the form to unconsciously align with its innate patterns of stability and adapt to its environment with resilience.

Through this experiential process, the Unconscious Earth offers the form opportunities to deepen its connection to balance and grounded presence. It supports the body's evolution from reactive patterns to embodied harmony, revealing the natural intelligence of the form's ability to stabilize and thrive. This cycle highlights the interplay between grounding and adaptability, allowing the form to unconsciously move in alignment with the rhythms of life and its physical foundation.

Gate 15: Modesty

The quality of behavior which expresses the proper balance between extremes.

Gate 15 exudes a magnetic presence that naturally draws others into its sphere of influence. Its unique gift lies in harmonizing extremes, understanding that the richness of life emerges from embracing the full range of personality extremes rather than avoiding its polarities. This gate has an innate ability to accept and adapt to the varied rhythms of others, seeing beauty in the diversity of human expression. Its energy resonates through the collective, offering the potential to unify individuals from all walks of life in pursuit of greater shared aspirations. Gate 15 thrives in environments of diversity and change, demonstrating remarkable flexibility and adaptability when faced with shifting circumstances.

While rigid routines or fixed structures may feel limiting, Gate 15's strength lies in its fluidity and openness to life's natural ebb and flow. By channeling its energy with intention, it becomes a powerful catalyst for collective transformation, fostering a profound appreciation for humanity's multifaceted nature. It serves as a reminder that true balance is not about moderation but about embracing and integrating life's extremes. Through its presence, Gate 15 inspires others to explore the full amplitude of life, to honor their own rhythms, and to find a unique sense of equilibrium amidst the complexities of the world.

Additional Gate Information:

- Incarnation Crosses: Vessel of Love, Extremes, Prevention
- Incarnation Quarter: Form (Civilization) - Cancer
- Energy Circuit: Understanding (Logical)
- Amino Acid: Serin
- Anatomy: Liver
- Gene Keys: Dullness (Impotent-Enslaved) - Magnetism - Florescence



Line 4: The Wallflower - No Fixing

Modesty as a shield against exposure of inadequacy.

↑ Jupiter: A genuine form that may/or may not mask inadequacies. The uncomfortableness of the Self when it is out of the flow.

↓ Saturn: An ultimately weak defense leading to exposure and humiliation. Extremism that keeps the Self out of the flow.

- Line Quality: Fixed on externalizing its single track quality.

In the upper trigram of this collective gate, the fourth line reveals humanity's deep paradox—having great influence through its fixed focus while feeling deeply inadequate. This line's awareness makes it acutely conscious of both its strengths and its perceived shortcomings, creating tension until it finds the right environment where its fixed nature belongs.

↑ Exaltation (Jupiter)

This line's Jupiter exaltation manifests through its genuine expression, which becomes highly influential when properly placed in the flow. Its one-tracked focus allows it to deeply impact others by remaining true to its fixed nature. For example, when this line finds an environment that aligns with its rhythm, its focus transforms from a perceived limitation into a profound gift that serves the greater whole.

Unlike lower trigram lines that adapt to circumstances, this line seeks specific relationships and environments that match its extreme rhythm. Jupiter's influence helps it maintain authenticity while seeking the right spaces where its fixed nature can thrive. In these environments, its focus becomes a powerful tool for creating harmony and influence within the collective.

↓ Detriment (Saturn)

This line's Saturn detriment manifests as isolation when its extreme nature creates separation from the natural flow. Feelings of inadequacy become particularly intense in environments that don't align with its rhythm. For instance, the line might experience painful awareness of misalignment when forced into situations that demand adaptability, amplifying its sense of being out of place.

The detriment transforms when the line accepts that its feelings of inadequacy are not flaws but signals guiding it toward better environments. Saturn teaches this line to stop using its fixed nature as a defense and instead recognize when it's simply in the wrong setting. By seeking spaces that naturally support its extreme focus, the line can turn isolation into



Introduction to Environmental Gates

Environmental Gates in your Venus Return represent additional characteristics that manifest in the people or specific individuals around you. Think of these characteristics as the backdrop of the scene in the movie of your Venus Return. These "characters" bring color and depth to the environment stipulated by the Venus Return Nodes and are certainly worth noticing; however, because they are designated as environmental activations, you are not intended to interact with these forces.

While your Shadow Mind may be tempted to engage with them, your inner authority will not—it inherently understands that these environmental themes are not meant for you to focus on or waste energy interacting with. These Environmental Gates and Lines are further influenced by the planet imprinting them. For example, Mercury may represent a background character attempting to communicate the essence of the gate and line it brings. You may observe this, but your authority will remain detached. Be aware, your Shadow Mind is influenced by everything!



Head Center

P/D	Gate & Line	Fixing	Filter	Venus Return Effect
Personality	63.3	None	Mars	Environmental

Conscious Mars - Venus Return: Environmental

During this cycle, you may notice someone who brings a clear and active energy to the gate and line imprinted by Mars in your chart. This person embodies Mars' energy of drive, action, and initiative, actively energizing the environment with momentum and determination. Through their courage and determination, they bring conscious attention to the themes and experiences associated with this gate and line.

However, this activation does not create a channel in your design, so your Inner Authority is unlikely to pay direct attention to this energy. Instead, their presence serves as a background influence within the environment, subtly encouraging you to take action, align with boldness, and channel your energy productively in areas tied to this part of your chart.

Gate 63: After Completion

After Completion: In the spiral of life, all ends are beginnings.

Gate 63 embodies the energy of doubt and questioning within the Logical Understanding family, scrutinizing collective patterns through a natural sense of suspicion. Its gift lies in formulating transformative questions that await the answers provided by Gate 4. This gate's power serves the process of scientific inquiry, though it requires caution when applied on a personal level. Its effectiveness emerges not from seeking answers but from engaging in the process of questioning itself. The strength of Gate 63 catalyzes transformation by forming precise inquiries, driving the expansion of knowledge boundaries toward a more secure understanding of the future. Its nature challenges it to balance skepticism without succumbing to overwhelming doubt, ensuring its questioning remains constructive rather than destructive.

The power of Gate 63 manifests as a catalyst for logical exploration, advancing collective awareness rather than seeking personal certainty. Its effectiveness depends on distinguishing between doubts that serve the collective and those that unnecessarily burden the individual. By using doubt constructively, this gate facilitates the establishment of reliable patterns through careful and deliberate questioning. Its purpose is to guide the collective journey through conscious and thoughtful inquiry rather than reflexive or unfocused skepticism. The impact of Gate 63 lies in its ability to question with precision, serving as a tool for progress and understanding within the larger framework of logical exploration.

Additional Gate Information:

- Incarnation Crosses: Consciousness, Doubts, Dominion
- Incarnation Quarter: Mind (Initiation) - Pisces
- Energy Circuit: Logical
- Amino Acid: Prolin
- Anatomy: Pineal Gland
- Gene Keys: Doubt (Self-doubt/Suspicion) - Inquiry - Truth



Line 3: Continuance - No Fixing

↑ Jupiter: The dedication to the new beginning that insists on maintaining its achieved principles despite having to interact with those who have not attained such a state. Doubts that one can maintain one's principles when interacting with others.

↓ Saturn: Success at any price. The pressure to eliminate the doubt at any cost.

- Line Quality: Attuning and adapting to a trial and error process.

Line 3 in Gate 63 learns through trial and error which questions are truly significant and which may be misaligned. Its experience reveals that questions evolve and change in relevance over time, requiring constant adaptation and refinement in its investigative process.

↑ Exaltation (Jupiter):

With Jupiter exalted, Line 3 demonstrates dedication to maintaining its questioning principles even when engaging with others' answers. For example, it naturally senses when external answers fail to fully resolve its doubts, preserving its commitment to finding resolutions that hold personal truth. This ability to remain steadfast in its process allows for meaningful inquiry while respecting others' perspectives.

Jupiter's expansive influence enriches Line 3's questioning process by fostering a balance between engaging with external knowledge and maintaining its authentic inquiry. It recognizes that not all answers, even if technically correct, will satisfy its specific doubts, enabling it to refine and adjust its questions while staying true to its need for personally meaningful resolution.

↓ Detriment (Saturn):

With Saturn in detriment, Line 3 may exhibit a rigid insistence on resolving doubts at any cost. For instance, this Saturnian influence can lead it to reject all external answers as insufficient, creating isolation in its questioning process and undermining its ability to learn from interactions with others.

Saturn's restrictive energy can also manifest as a compulsive drive to eliminate doubt immediately, blocking the natural unfolding of understanding through trial and error. Instead of recognizing when questions are misaligned or require adjustment, Line 3 may persist in demanding answers that cannot truly satisfy, stalling its investigative growth.



Ajna Center

P/D	Gate & Line	Fixing	Filter	Venus Return Effect
-----	-------------	--------	--------	---------------------

You have no Environmental planet imprints in this center.



Throat Center

P/D	Gate & Line	Fixing	Filter	Venus Return Effect
-----	-------------	--------	--------	---------------------

You have no Environmental planet imprints in this center.



G Center

P/D	Gate & Line	Fixing	Filter	Venus Return Effect
Design	10.1	Exalted	Venus	Environmental

Unconscious Venus - Venus Return: Environmental

During this cycle, your form may become aware of someone who embodies the energy of Venus, emphasizing themes of discernment, values, and the beauty of refinement through the gate and line imprinted. This person may encourage you to reflect on what truly matters in your relationships, creativity, and sense of self-worth.

However, their presence is primarily intended to enrich the environment around you, as this activation does not form a channel in your design. Consequently, your inner authority is unlikely to engage directly with this energy.

Gate 10: Treading

The underlying code of behavior which ensures successful interaction despite circumstances.

Gate 10 represents the essence of individual behavior and self-love, offering an innate understanding of how to navigate life through appropriate conduct in various situations. It carries a deep awareness of the pivotal role behavior plays in interacting with the world, often evaluating the actions of others based on this understanding. At its core, Gate 10 is rooted in self-love, which serves as the foundation for all other forms of love. This self-love empowers it to adapt to changing circumstances while remaining true to its authentic nature. Through its unique expression, Gate 10 demonstrates the power of individuality and appropriate behavior, becoming a guiding example for others and contributing to a more harmonious collective experience.

The behavior of Gate 10 is a profound instrument of change and influence, embodying the rare ability to balance situationally appropriate conduct with unwavering personal authenticity. This quality allows it to bridge the gap between societal expectations and individual truth, fostering genuine connections with others while inspiring them to embrace their unique selves. Gate 10's capacity to navigate life with such grace and integrity makes it a transformative force, encouraging both personal and collective growth. By remaining true to its individuality, Gate 10 not only enriches its own experience but also acts as a beacon for others, illustrating how authenticity and self-love can coexist with meaningful and impactful interactions in the world.

Additional Gate Information:

- Incarnation Crosses: Vessel of Love, Behavior, Prevention
- Incarnation Quarter: Spirit (Mutation) - Capricorn
- Energy Circuit: Centering & Integration
- Amino Acid: Arginin
- Anatomy: Chest
- Gene Keys: Self-Obsession (Self-Denying-Narcissistic) - Naturalness - Being



Line 1: Modesty - Exalted

An innate sense to know and accept one's place.

↑ **Sun:** A valued sense of purpose no matter what the position. The ability to know one's place and how to act despite circumstances.

- Line Quality: The Basis of the Hexagram; the investigative introspection.

This line investigates how to be authentic in any position, like a new employee who naturally learns to be effective whether working with executives or janitors. Through careful observation, they discover how to maintain genuine behavior regardless of status or role.

↑ **Exaltation (Sun):**

The exalted quality of this line shines through like a skilled nurse who's equally comfortable assisting surgeons or helping orderlies - completely natural in every interaction because they've accepted their role without ego. Their authentic presence comes from understanding that every position has its purpose.

Through this self-acceptance, they adapt effortlessly to any situation. Like a substitute teacher who can walk into any classroom level and immediately connect with students - not by pretending to be something they're not, but by being genuinely themselves while respecting the context.



Heart Center

P/D	Gate & Line	Fixing	Filter	Venus Return Effect
Personality	40.4	Exalted	South Node	Environmental
Design	40.6	Juxtaposed	South Node	Environmental

Conscious South Node - Venus Return: Environment Direction

The Personality South Node represents your conscious relationship to environmental resonance and alignment during this cycle. This directional force subtly guides you toward environments shaped by the gate and line it imprints, creating a backdrop that supports the cycle’s flow. Its energy highlights the presence of people or characteristics within these environments that naturally resonate with this phase of the journey.

However, because this activation does not create a channel in your design, your Inner Authority is unlikely to actively engage with this energy. Instead, the South Node’s influence operates in the background, encouraging you to simply notice and acknowledge the qualities or individuals present in these spaces. These environmental elements are part of the background meant to support this cycle’s unfolding.

Gate 40: Deliverance

The point of transition between struggle and liberation.

Gate 40 embodies the energy of tribal deliverance, balancing a deep need for aloneness with its role as a provider for the family (Gate 37) and the larger tribal community. Its willpower operates in natural cycles of work and rest, thriving when this balance is respected. While Gate 40 feels a strong sense of responsibility to provide, it also has an innate desire for solitude, which can create tension when family or community demands become overwhelming. Its initial response to requests is often “no,” though this resistance can soften when a fair exchange or genuine appreciation is offered. Recognition and gratitude for its efforts are vital for Gate 40 to thrive, as it naturally loves to work when its need for rest and boundaries is honored. However, it must remain vigilant against manipulation through insincere appreciation aimed at maintaining its productivity.

The true challenge for Gate 40 lies in setting clear boundaries and effectively communicating its needs to avoid overextending its willpower, which has limits. Without proper rest, it risks serious burnout, making wise management of its energy essential. In relationships, Gate 40 requires fair bargains that respect its need for alone time and recovery, ensuring that its role as a provider does not come at the expense of its well-being. By honoring its need for rest and solitude, Gate 40 not only protects its own energy but also enhances its ability to serve the family and community. Its willpower is a valuable resource, and when managed wisely, it fulfills its provider role with strength and sustainability, ensuring the balance between giving to others and caring for itself.

Additional Gate Information:

- Incarnation Crosses: Planning, Denial, Migration
- Incarnation Quarter: Relationships (Duality) - Virgo
- Energy Circuit: Tribal
- Amino Acid: Glysine
- Anatomy: Stomach
- Gene Keys: Exhaustion (Acquiescent/Contemptuous) - Resolve - Divine Will



Line 4: Organization - Exalted

↑ **Uranus:** The power to transform and the intuitive intellect to select and organize for the purpose of maintaining deliverance. The power of the ego when organized and active, to maintain separateness.

- Line Quality: Fixed on externalizing its single track quality.

Line 4, positioned in its fixed nature, externalizes its power by organizing the material plane to support and maintain healthy rest cycles. Its one-track focus on creating structured systems determines whether it achieves sustainable balance or succumbs to patterns of overwork. Operating transpersonally, Line 4 influences how others relate to the interplay between willpower and rest.

↑ Exaltation (Uranus):

Uranus grants Line 4 an intuitive ability to organize its material life in ways that protect its need for restoration. For example, Line 4 might create a structured work schedule with intentional breaks, ensuring both productivity and recovery. This genius for arranging its environment supports both itself and others by promoting balance between engagement and rest.

Line 4's transpersonal influence naturally extends to organizing supportive systems for those around it. Through its focus on reliable structures, Line 4 demonstrates how thoughtful organization can create space for essential withdrawal. This externalized wisdom allows it to model sustainable energy management, benefiting the tribe through its example.

Unconscious South Node - Venus Return: Environmental Direction

The Design North Node represents your form's unconscious resonance with future environmental alignment during this cycle. This directional force subtly guides your body toward new and unfamiliar environments shaped by the gate and line it imprints, creating a physical backdrop that supports the cycle's growth and expansion. Its energy unconsciously aligns your form with people or characteristics within these future spaces that are essential for the next phase of your journey.

Because this activation does not create a channel in your design, your Inner Authority is unlikely to directly engage with this energy. Instead, the North Node's influence operates in the background, gradually drawing your form toward the qualities or individuals present in these new environments. These elements act as a passive yet vital foundation, supporting the cycle's evolution and guiding your form toward its natural trajectory.

Gate 40: Deliverance

The point of transition between struggle and liberation.

Gate 40 embodies the energy of tribal deliverance, balancing a deep need for aloneness with its role as a provider for the family (Gate 37) and the larger tribal community. Its willpower operates in natural cycles of work and rest, thriving when this balance is respected. While Gate 40 feels a strong sense of responsibility to provide, it also has an innate desire for solitude, which can create tension when family or community demands become overwhelming. Its initial response to requests is often "no," though this resistance can soften when a fair exchange or genuine appreciation is offered. Recognition and gratitude for its efforts are vital for Gate 40 to thrive, as it naturally loves to work when its need for rest and boundaries is honored. However, it must remain vigilant against manipulation through insincere appreciation aimed at maintaining its productivity.



The true challenge for Gate 40 lies in setting clear boundaries and effectively communicating its needs to avoid overextending its willpower, which has limits. Without proper rest, it risks serious burnout, making wise management of its energy essential. In relationships, Gate 40 requires fair bargains that respect its need for alone time and recovery, ensuring that its role as a provider does not come at the expense of its well-being. By honoring its need for rest and solitude, Gate 40 not only protects its own energy but also enhances its ability to serve the family and community. Its willpower is a valuable resource, and when managed wisely, it fulfills its provider role with strength and sustainability, ensuring the balance between giving to others and caring for itself.

Additional Gate Information:

- Incarnation Crosses: Planning, Denial, Migration
- Incarnation Quarter: Relationships (Duality) - Virgo
- Energy Circuit: Tribal
- Amino Acid: Glysine
- Anatomy: Stomach
- Gene Keys: Exhaustion (Acquiescent/Contemptuous) - Resolve - Divine Will



Line 6: Decapitation - Juxtaposed

The necessary destruction of inferior forces in positions of power before liberation can take place.

↑ **Sun:** The authority, coupled with the magnanimity to remove from power only those which deserve such drastic treatment. The power and authority of the ego to eject individuals in legitimate defense of the group.

↓ **Earth:** Exemplified by the terror of the French Revolution, where the idea of who was deserving of punishment was cruelly extended to an entire class. The distortion of the ego through power and authority.

- Line Quality: Transition maturation with a perspective beyond the gate and circuit. The role model.

- Transition: 64.1 - Conditions

From its rooftop perspective, Line 6 sees beyond individual demands on willpower to the broader dynamics of the entire tribal circuit. Early experiences teach Line 6 to differentiate between merely negative forces—those making legitimate but unsuitable demands—and inferior forces—those that are unfair or deceptive in their demands on willpower. This distinction becomes crucial in maintaining the integrity of the tribe.

↑ Exaltation (Sun):

The Sun grants Line 6 the authority and discernment to identify and remove truly inferior forces that corrupt the tribe's willpower. Like a wise overseer, Line 6 recognizes the difference between forces that are simply misaligned and those that actively damage the group through false bargains. For example, Line 6 might reject a deceptive leader whose manipulative demands undermine the tribe's cohesion, protecting the group from further harm.

Line 6's rooftop perspective allows it to understand how eliminating inferior influences safeguards not only individual willpower but also the entire tribal system. By exercising its authority judiciously, Line 6 ensures the tribe's integrity and proper functioning, benefiting everyone involved.

↓ Detriment (Earth):

Under The Earth's detriment, Line 6's authority can become distorted, leading to excessive rejection of entire categories of influence rather than targeting specific inferior forces. For example, after experiencing betrayal, Line 6 might condemn all tribal demands as corrupt, severing legitimate connections alongside harmful ones. This wholesale rejection undermines the group's stability.

Instead of using its perspective for wise oversight, Line 6 may fall into patterns of isolation. Its inability to distinguish between misaligned and inferior forces causes a breakdown in tribal bonds. This reactive approach, driven by betrayal, distorts Line 6's natural authority, preventing it from protecting and nurturing proper willpower dynamics.



Splenic Center

P/D	Gate & Line	Fixing	Filter	Venus Return Effect
-----	-------------	--------	--------	---------------------

You have no Environmental planet imprints in this center.



Sacral Center

P/D	Gate & Line	Fixing	Filter	Venus Return Effect
-----	-------------	--------	--------	---------------------

You have no Environmental planet imprints in this center.



Solar Plexus Center

P/D	Gate & Line	Fixing	Filter	Venus Return Effect
Personality	37.4	None	North Node	Environmental
Personality	37.3	None	Mercury	Environmental
Design	37.6	Detriment	North Node	Environmental
Design	36.4	None	Saturn	Environmental

Conscious North Node - Venus Return: Environment Direction

The Personality North Node represents your conscious connection to the environments that support growth and forward movement during this cycle. This directional force subtly draws you toward spaces shaped by the gate and line it imprints, highlighting people or characteristics within these environments that align with the cycle’s trajectory. These elements act as a background influence, pointing toward the potential for expansion and evolution during this phase.

Because this activation does not create a channel in your design, your Inner Authority is unlikely to actively engage with this energy. Instead, the North Node’s influence shapes the environment itself, encouraging you to notice and acknowledge the qualities or individuals present in these spaces. These environmental elements are intentionally part of the backdrop, supporting the unfolding of the cycle’s future direction.

Gate 37: The Family

The manifestation macro-and micro-cosmically of the organic nature of communities.

Gate 37 serves as the cornerstone of the family unit, naturally expanding its influence into the broader tribal community. As part of the Community Channel, it is designed to nurture and harmonize within groups, offering a foundation of emotional sensitivity and affection. This gate thrives on creating and maintaining bonds through touch, care, and an intuitive understanding of relationships. It embodies the concept of bargaining, instinctively seeking mutually beneficial arrangements that strengthen connections. Gate 37’s energy often motivates Gate 40’s willpower to provide for the family, creating a dynamic interplay of resources and emotional support. However, its challenge lies in balancing the need for recognition and resources with the greater goal of maintaining harmony within the group.

The true gift of Gate 37 is its ability to hold communities together through a nurturing and appreciative spirit. It plays a vital role in distributing resources and affection within the family structure while carefully navigating the emotional waves and dynamics of group relationships. By upholding loyalty and tradition, Gate 37 fosters stability, yet it also adapts to shifting emotional needs to ensure fairness and balance. When guided by Inner Authority, this energy contributes to deep, meaningful connections that sustain and strengthen the bonds of family and community. Its capacity to harmonize and nurture is a powerful force that builds lasting foundations, ensuring the well-being of those it serves.

Additional Gate Information:

- Incarnation Crosses: Planning, Bargains, Migration
- Incarnation Quarter: Mind (Initiation) - Pisces
- Energy Circuit: Tribal
- Amino Acid: Proline



- Anatomy: Mouth. Dorsal Ganglia
- Gene Keys: Weakness (Over-Sentimental / Cruel) - Equality - Tenderness

Line 4: Leadership by Example - No Fixing

Any member of the family may take on a leading role through exemplary behavior.

↑ Moon: The manifestation of the highest principles in everyday and practical affairs. The possibility of the highest principles in all relationships resulting in a leadership role.

↓ Saturn: A conservatism that generally only accepts the leadership of the father, who may or may not be a valued role model. The possibility of being insensitive to the leadership of anyone other than those accepted by tradition.

- Line Quality: Fixed on externalizing its single track quality.

Line 4 embodies a fixed, externalized focus on leadership through demonstrable resource provision. Its one-track nature shows how any family member can assume leadership by proving their practical value. This creates a natural tension between traditional authority and leadership based on demonstrated capability.

↑ Exaltation (Moon):

The Moon gives Line 4 the ability to manifest leadership by translating principles into practical results. Its single-track focus draws it to demonstrate value through tangible contributions to family resources. For example, Line 4 might step into a leadership role during a financial crisis by organizing resources and ensuring family needs are met, naturally establishing its authority through action rather than position.

Line 4's gift lies in showing that leadership emerges from meeting family needs. It understands that principles must be grounded in practical support for the tribe. This alignment between values and action creates authentic authority, inspiring others to recognize leadership based on demonstrated value rather than traditional hierarchies.

↓ Detriment (Saturn):

Saturn brings a tendency toward rigid adherence to traditional leadership structures. Line 4's one-track nature can fixate on conventional authority figures, even when they fail to provide necessary resources. For example, it might continue to respect a family patriarch who no longer contributes, creating tension between formal position and practical provision.

The detriment creates conflict between traditional leadership and those who provide real support. Line 4's fixed focus may prioritize position over practical value, disrupting the natural flow of authority to those who demonstrate capability. This rigidity can prevent the family from adapting to new dynamics and recognizing emerging leaders who lack traditional standing.



Conscious Mercury - Venus Return: Environmental

During this cycle, you may notice someone who brings a clear and active energy to the gate and line imprinted by Mercury in your chart. This person embodies Mercury's energy of communication and intellectual curiosity, naturally influencing the environment with ideas, conversations, and mental clarity. Through their words and insights, they bring conscious attention to the themes and experiences associated with this gate and line.

However, this activation does not create a channel in your design, so your Inner Authority is unlikely to pay direct attention to this energy. Instead, their presence serves as a background influence within the environment, subtly inspiring you to explore new perspectives, refine how you express yourself, and engage with the mental themes tied to this part of your chart.

Gate 37: The Family

The manifestation macro-and micro-cosmically of the organic nature of communities.

Gate 37 serves as the cornerstone of the family unit, naturally expanding its influence into the broader tribal community. As part of the Community Channel, it is designed to nurture and harmonize within groups, offering a foundation of emotional sensitivity and affection. This gate thrives on creating and maintaining bonds through touch, care, and an intuitive understanding of relationships. It embodies the concept of bargaining, instinctively seeking mutually beneficial arrangements that strengthen connections. Gate 37's energy often motivates Gate 40's willpower to provide for the family, creating a dynamic interplay of resources and emotional support. However, its challenge lies in balancing the need for recognition and resources with the greater goal of maintaining harmony within the group.

The true gift of Gate 37 is its ability to hold communities together through a nurturing and appreciative spirit. It plays a vital role in distributing resources and affection within the family structure while carefully navigating the emotional waves and dynamics of group relationships. By upholding loyalty and tradition, Gate 37 fosters stability, yet it also adapts to shifting emotional needs to ensure fairness and balance. When guided by Inner Authority, this energy contributes to deep, meaningful connections that sustain and strengthen the bonds of family and community. Its capacity to harmonize and nurture is a powerful force that builds lasting foundations, ensuring the well-being of those it serves.

Additional Gate Information:

- Incarnation Crosses: Planning, Bargains, Migration
- Incarnation Quarter: Mind (Initiation) - Pisces
- Energy Circuit: Tribal
- Amino Acid: Proline
- Anatomy: Mouth. Dorsal Ganglia
- Gene Keys: Weakness (Over-Sentimental / Cruel) - Equality - Tenderness



Line 3: Evenhandedness - No Fixing

The success of any group is dependent on maintaining order.

↑ Jupiter: The ability to judge what behavior is appropriate and to react in a balanced manner to transgressions. The possibility to have the sensitivity to know what behavior is appropriate in a relationship.

↓ Mars: An ironic tendency to either test incessantly the borders of acceptability or to respond to the very same tendency in others with severity. A possible lack of sensitivity to the appropriateness of behavior in relationships.

- Line Quality: Attuning and adapting to a trial and error process.

Line 3 brings a natural process of trial and error to tribal dynamics, testing which behaviors maintain family order and secure resources. Through cycles of allegiance and separation, it experiences the making and breaking of bonds. Line 3's adaptability allows it to sense when changing conditions require adjustments in tribal conduct, even though this process can sometimes create instability.

↑ Exaltation (Jupiter):

Jupiter gives Line 3 a balanced sensitivity to behaviors that foster tribal harmony. Through its trial and error process, it discovers which actions maintain order and ensure access to resources. For example, Line 3 might observe that flexibility in enforcing family rules during challenging times can actually strengthen bonds and secure cooperation, while overly rigid behavior can lead to conflict.

Line 3's adaptability allows it to adjust behavioral standards based on changing circumstances. This flexibility ensures that tribal order is preserved without compromising access to vital resources. Its wisdom lies in knowing when to enforce rules and when to allow exceptions, creating a stable environment that supports the family or community through transitions.

↓ Detriment (Mars):

Mars influences Line 3 with a tendency to either test boundaries or enforce them too harshly. This dynamic can lead to instability in tribal bonds and resource flow. For example, Line 3 might overcorrect by punishing others for breaking rules it once ignored, creating confusion and tension within family or group dynamics.

Mars' shadow may cause Line 3 to adapt in ways that appear insensitive to others' needs. Its trial and error process can lead to sudden shifts in behavior that disrupt relationships and undermine trust. What begins as an effort to respond to changing conditions can escalate into unnecessarily harsh enforcement of new rules, creating waves of instability as others struggle to adjust.



Unconscious North Node - Venus Return: Environment Direction

The Design South Node represents your form's unconscious resonance with environmental alignment during this cycle. This directional force subtly guides your body toward environments shaped by the gate and line it imprints, creating a physical backdrop that supports the cycle's natural flow. Its energy unconsciously aligns your form with the presence of people or characteristics within these spaces that resonate with this phase of the journey.

Because this activation does not create a channel in your design, your Inner Authority is unlikely to directly engage with this energy. Instead, the South Node's influence operates silently in the background, allowing your form to unconsciously adapt to and resonate with the qualities or individuals present in these environments. These elements serve as an essential but passive foundation, supporting the unfolding of the cycle in subtle and natural ways.

Gate 37: The Family

The manifestation macro-and micro-cosmically of the organic nature of communities.

Gate 37 serves as the cornerstone of the family unit, naturally expanding its influence into the broader tribal community. As part of the Community Channel, it is designed to nurture and harmonize within groups, offering a foundation of emotional sensitivity and affection. This gate thrives on creating and maintaining bonds through touch, care, and an intuitive understanding of relationships. It embodies the concept of bargaining, instinctively seeking mutually beneficial arrangements that strengthen connections. Gate 37's energy often motivates Gate 40's willpower to provide for the family, creating a dynamic interplay of resources and emotional support. However, its challenge lies in balancing the need for recognition and resources with the greater goal of maintaining harmony within the group.

The true gift of Gate 37 is its ability to hold communities together through a nurturing and appreciative spirit. It plays a vital role in distributing resources and affection within the family structure while carefully navigating the emotional waves and dynamics of group relationships. By upholding loyalty and tradition, Gate 37 fosters stability, yet it also adapts to shifting emotional needs to ensure fairness and balance. When guided by Inner Authority, this energy contributes to deep, meaningful connections that sustain and strengthen the bonds of family and community. Its capacity to harmonize and nurture is a powerful force that builds lasting foundations, ensuring the well-being of those it serves.

Additional Gate Information:

- Incarnation Crosses: Planning, Bargains, Migration
- Incarnation Quarter: Mind (Initiation) - Pisces
- Energy Circuit: Tribal
- Amino Acid: Proline
- Anatomy: Mouth. Dorsal Ganglia
- Gene Keys: Weakness (Over-Sentimental / Cruel) - Equality - Tenderness



Line 6: Purpose - Detriment

The energy to maintain the family is enhanced by recognizing its values.

↓ **Mercury:** A need for diversity that may ignore the achievements of the family in favor of withdrawal. The need for diversity that despite appreciation will prefer casual friendships.

- Line Quality: Transition maturation with a perspective beyond the gate and circuit. The role model.

- Transition: 63.1 - Composure

Line 6 seeks a family bond that transcends the mundane and reaches toward the divine. In its youth, it experiments subjectively with different forms of spiritual family, often rejecting conventional family structures in search of higher truth. During the roof phase, it observes how family can serve as a vehicle for divine connection. Finally, Line 6 emerges as a role model, demonstrating how true family purpose extends beyond the nuclear unit into universal communion.

↓ **Detriment (Mercury):**

Mercury brings restlessness to Line 6 during its early experimental phase, fueling an endless search for the perfect spiritual family. This constant seeking may lead it to reject ordinary family connections, failing to recognize divine presence in simple, everyday interactions. For example, Line 6 might overlook the spiritual value of its biological family while pursuing an idealized vision of divine connection elsewhere.

During the roof phase, this Mercurial influence can turn Line 6's observation into an endless theoretical study of spiritual family systems. Instead of preparing to embody higher family wisdom, it may become trapped in impractical ideals, delaying its emergence as a role model. This intellectual detachment limits its ability to ground its spiritual insights in real family experiences.



Unconscious Saturn - Venus Return: Environmental

During this cycle, your form may become aware of someone who embodies the stabilizing and disciplining energy of Saturn, expressing the themes of the gate and line imprinted with precision, structure, and resilience.

This person's presence may illuminate the value of boundaries and measured release within you, encouraging a deeper understanding of discipline and the structured energy of this gate and line. Their influence may feel grounding, offering a sense of stability or a framework to navigate physical or material challenges. However, their impact is primarily intended to enrich the environment around you, as this activation does not form a channel in your design. As a result, your inner authority is unlikely to engage directly with this energy.

Gate 36: The Darkening of the Light

The rule of cycles in which decline is a natural but not enduring stage.

Gate 36 is associated with inexperience and crisis within the Abstract Sensing Family. As part of the Transitoriness Channel, it is designed for initiation into new experiences, driven by the natural ebb and flow of emotional waves. Its energy is characterized by an intense hunger for experience, generating and releasing powerful feelings as it encounters the unknown. This gate naturally leads to crises—both large and small—as a result of its inexperience. These crises are not setbacks but opportunities for growth, much like the process of learning to ride a bicycle, where initial instability eventually transforms into mastery. However, Gate 36 is not designed to control or manifest experiences directly; instead, it must navigate the emotional highs and lows of its "hope and pain" wave as it seeks fulfillment.

The true value of Gate 36 lies not in the constant pursuit of experiences but in the wisdom gained from overcoming each crisis. Its gift is the ability to transform inexperience into profound emotional growth and a deeper understanding of life. When guided by Inner Authority, Gate 36 can navigate emotional turbulence with clarity, allowing it to embrace change and crisis as essential teachers. This energy seeks balance amid emotional challenges, ultimately offering valuable insights that arise from its journey. By moving through the highs and lows of its emotional wave, Gate 36 embodies the potential for transformation and the wisdom that comes from living life fully.

Additional Gate Information:

- Incarnation Crosses: Eden, Crisis, Plane
- Incarnation Quarter: Mind (Initiation) - Pisces
- Energy Circuit: Sensing (Abstract)
- Amino Acid: Prolin
- Anatomy: Solar Plexus
- Gene Keys: Turbulence (Nervousness / Crisis Prone) - Humanity - Compassion



Line 4: Espionage - No Fixing

↑ **Pluto:** Not Active (active from 2063.04.06) - The ability to prepare for and anticipate decline through the accumulation of secret or privileged information. The realization that knowledge both covert and esoteric is necessary, if one is to be prepared for crisis and change.

↓ **Moon:** The tendency in recognizing the strengths of the opposition to accept the inevitability of decline and rather than resist, to offer one's services to guarantee survival. The double agent. Crisis knowledge that is available to others for a price.

- Line Quality: Fixed on externalizing its single track quality.

Line 4 possesses a penetrating perception of others, driven by an almost obsessive need to understand how people operate. This fixed focus on observing and analyzing others gives Line 4 unique insight into human patterns and motivations. Its social awareness operates at a deeper level, naturally gathering privileged information about others. However, this intense focus on others often leaves Line 4 blind to its own patterns until crisis forces self-reflection.

↑ Exaltation (Pluto - Inactive until 2063):

Pluto enhances Line 4's natural talent for reading between the lines of human behavior and anticipating change. For example, Line 4 might notice subtle shifts in tone or emotional energy within a group, signaling an upcoming conflict or transition. This deep emotional awareness becomes a protective mechanism, allowing Line 4 to prepare for changes before they occur. Its ability to tune into the emotional undercurrents of people and situations uncovers the hidden motivations driving their actions.

This Plutonian influence transforms Line 4's perceptive abilities into profound psychological insight. By reading the subtle emotional dynamics at play, Line 4 becomes skilled at forming alliances and navigating complex social landscapes. This accumulated knowledge helps Line 4 position itself advantageously, avoiding unnecessary crises and preparing for major transitions. However, the full potential of this gift is realized only when Line 4 learns to integrate self-awareness with its deep understanding of others.

↓ Detriment (Moon):

The Moon's influence can lead Line 4 to use its insights as leverage rather than understanding. For instance, Line 4 might exploit its knowledge of a colleague's vulnerabilities to gain an advantage in professional negotiations. This transactional approach to privileged information creates complicated allegiances, turning its remarkable insight into a commodity to be traded for personal gain or security.

Caught in this Lunar detriment, Line 4 may become overly adaptable to others' patterns, losing touch with its own truth. Its focus on observing and responding to external dynamics leaves it vulnerable to internal blind spots. This imbalance often results in crises when Line 4 is forced to confront unexamined personal patterns. By maintaining ethical boundaries and developing self-awareness alongside its deep understanding of others, Line 4 can avoid these pitfalls and use its gift for growth and mutual benefit.



Root Center

P/D	Gate & Line	Fixing	Filter	Venus Return Effect
Personality	53.1	None	Jupiter	Environmental
Design	58.3	Detriment	Mars	Environmental

Conscious Jupiter - Venus Return: Environmental

During this cycle, you may encounter someone who naturally embodies the expansive and optimistic qualities of Jupiter, bringing a vibrant energy to the gate and line imprinted by Jupiter in your chart. This person's presence may infuse the environment with a sense of growth, wisdom, and opportunity. Through their ability to align with principles of protection and abundance, they draw conscious attention to the themes connected to this gate and line.

However, because this activation does not create a channel in your design, your Inner Authority is unlikely to pay direct attention to this energy. Instead, their presence serves as a background influence within the environment, subtly encouraging you to reflect on themes of growth, security, and wisdom in the areas tied to this part of your chart. Their influence may inspire you to consider how you create stability and abundance in alignment with your values and aspirations.

Gate 53: Development

The expansion of the resources which maximizes the development of full potential.

Gate 53 represents the pressure to initiate new cycles and experiences, driving the momentum for renewal and fresh beginnings. As part of the Abstract Sensing family, it thrives on beginning processes, often manifesting as restlessness or a push for new opportunities. This vital pressure fuels progress, but without the freedom to start something new, it can lead to stress, boredom, or even depression. Without the balancing energy of Gate 42 (which completes the Channel of Maturation), Gate 53 may struggle to finish what it starts or become stuck in unfinished pursuits. However, it naturally encounters Gate 42's energy through interactions with others or planetary transits, allowing for eventual resolution and maturation of its initiated cycles.

Known as the "Gate of Beginnings," Gate 53 excels at generating momentum and breaking stagnation, making it a powerful force for personal and collective growth. Its challenge lies in balancing its pressure for new experiences with the need for completion, ensuring its energy is used effectively. Guided by Inner Authority, it can align its pressure with meaningful pursuits, initiating cycles that inspire progress and evolution. The stress inherent in Gate 53 serves as a positive motivator for change when properly directed, rather than becoming restless anxiety. Its ability to disrupt inertia and catalyze new endeavors makes it an essential contributor to growth, with its completion capacity emerging naturally through external influences and the right timing.

Additional Gate Information:

- Incarnation Crosses: Penetration, Beginnings, Cycles
- Incarnation Quarter: Form (Civilization) - Cancer
- Energy Circuit: Abstract
- Amino Acid: Serin
- Anatomy: Urogenital Diaphragm
- Gene Keys: Immaturity (Solemn-Fickle) - Expansion - Superabundance



Line 1: Accumulation - No Fixing

↑ **Neptune:** The dissolution of old forms but not at the expense of valued components that will be retained and transformed. The pressure to begin something new, not from scratch but based on the foundation of the old.

↓ **Venus:** Development hampered by criticism and the tendency to withdraw rather than make use of these experiences. The difficulty in starting something new because of the criticism that accompanied the old.

- Line Quality: Introspective and investigating.

Line 1 in Gate 53 is designed to deeply examine the foundations of new beginnings through careful introspection. Its role focuses on understanding how past experiences and completions inform future cycles, all while navigating the pressure to initiate fresh starts in an authentic and sustainable way.

↑ Exaltation (Neptune):

Neptune enhances Line 1's ability to gracefully dissolve outdated forms while preserving their essential value. For example, when reflecting on a completed project, Line 1 identifies which elements of that experience are worth carrying forward into new ventures. This selective transformation process ensures that each new beginning is built on a strong, evolved foundation.

Through its introspective nature, Line 1 naturally senses how to build upon past experiences instead of starting completely anew. This Neptunian influence helps it recognize patterns of development and retain valuable components, creating continuity between cycles. Line 1's investigative approach transforms the pressure to begin into a constructive process that benefits both personal and collective growth.

↓ Detriment (Venus):

Venus introduces a focus on unresolved criticisms from the past that can interfere with Line 1's ability to initiate new cycles. For instance, instead of using its investigative nature to integrate lessons from a failed project, Line 1 may dwell on negative experiences, leading to hesitation and withdrawal. This creates a pattern of avoiding past completions, which hinders authentic new beginnings.

This Venusian detriment can result in premature abandonment of projects at the first sign of difficulty, leaving cycles incomplete. Over time, the accumulation of unfinished business increases the pressure and difficulty of starting new ventures. Rather than building upon past wisdom, Line 1 risks repeatedly starting from scratch, preventing the natural progression and structured development that its design is meant to embody.



Unconscious Mars - Venus Return: Environmental

During this cycle, your form may become aware of someone who embodies the instinctive and dynamic energy of Mars, expressing the themes of the gate and line imprinted with vitality and force.

This person's presence may awaken a natural drive within you, encouraging bold action and engagement with the energy of this gate and line, propelling you forward with courage and determination. However, their influence is primarily intended to enrich the environment around you, as this activation does not form a channel in your design. As a result, your inner authority is unlikely to engage directly with this energy.

Gate 58: The Joyous

Stimulation is the key to joy.

The Joy of Perfection, represented by Gate 58, manifests as a vital force that drives the testing and refinement of patterns through challenging authority and improving the world. This energy expresses itself through an inherent zest for life and a deep-seated desire to be of service, requiring its natural partner, Gate 18, to effectively identify areas worthy of improvement. The characteristics of this gate are not learned but exist as innate qualities, demanding that its powerful energy be channeled constructively through natural joy and vitality.

When aligned with Strategy and Inner Authority, Gate 58's effectiveness emerges naturally, attracting opportunities for expression and fostering supportive connections. Its power lies in a profound love of life and an innate drive to challenge collective imperfection, serving humanity's progress through the application of vital energy. Success comes through patience in timing improvements rather than constant action, with strength emerging from natural enthusiasm rather than forced perfectionism. Through joyful experimentation, this energy serves as a catalyst for evolutionary progress, contributing to the collective development of human consciousness.

Additional Gate Information:

- Incarnation Crosses: Service, Vitality, Demands
- Incarnation Quarter: Spirit (Mutation) - Capricorn
- Energy Circuit: Logical
- Amino Acid: Serin
- Anatomy: Perineum
- Gene Keys: Dissatisfaction (None / Interfering) - Vitality - Bliss



Line 3: Electricity - Detriment

↓ **Mars:** The quality of fire is dependent on its fuel and subject to its influence, good or bad. The energy for aliveness that is dependent on others for stimulation.

- Line Quality: Attuning and adapting to a trial and error process.

Line 3 in Gate 58 moves through a trial-and-error process to discover how its vital energy operates independently and in collaboration with others. This experimental nature creates a dynamic tension between self-generated stimulation and collaborative energetic expression.

↓ **Detriment (Mars):**

With Mars in detriment, Line 3's energy can become overly dependent on external stimulation, creating a reactive rather than proactive approach to experimentation. For instance, it may repeatedly fall into cycles of responding to others' initiatives rather than generating its own, leading to a pattern of dependency that compromises its experimental process.

This Martian influence creates fluctuations in Line 3's energy based on the quality of external stimulation, resulting in inconsistent outcomes. Its trial-and-error process may become more focused on adapting to others' needs than building independent initiatives. To break free from this cycle, Line 3 must learn to trust its own vitality as a source of momentum for innovation and growth.



The Not-Self: Your Undefined Centers

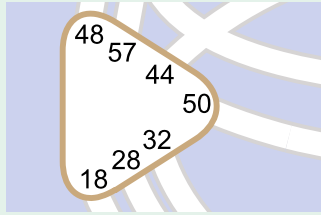

Venus Cycle Center Theme: Undefined Splenic Center

Exploring Intuition, Health, and Survival

In this Venus Cycle, your Splenic Center remains undefined, which means your experiences with real-time awareness, instincts, intuition, judgment and well-being will continue to vary based on your environment and the people around you. The Splenic Center governs primal awareness, health, survival instincts, and immunity—offering a sense of safety and intuition about what is right in the moment.

With an undefined Splenic Center, your awareness responses aren't as consistent or immediate as those with a defined Spleen. While individuals with a defined Spleen often instantaneous, confident awareness, yours may emerge more gradually, through reflection, or sometimes not at all. This undefined nature means you are highly sensitive to the energies of others, particularly their fears, health concerns, or well-being. This sensitivity can amplify the fears and lack of well-being of those around you, making it essential to stay aware of the people in your environment.

Because you lack a constant internal guide for health and survival, your strategies for maintaining well-being may shift over time. You might find yourself exploring different health practices, trends, or advice from others as you search for what truly works for you. While this exploration can feel uncertain at times, it also offers you the potential to gain deep wisdom about health and vitality through lived experience.

Your survival instincts may not always be as sharp as those with a defined Spleen, which can sometimes cause you to overlook early warning signs regarding your physical, mental, or emotional well-being. You might find yourself staying in unhealthy situations—whether relationships, jobs, or habits—longer than is beneficial, as your mind rationalizes holding onto what isn't serving you. Over time, however, you can learn to identify these signals in hindsight and use this awareness to make healthier choices moving forward.

On the positive side, the absence of a constant survival instinct means you are less likely to make decisions rooted in fear. This can make you more open to taking risks and embracing the unknown, as you are not tied to the immediate anxieties that others might feel. However, this openness can sometimes expose you to unnecessary risks or harmful situations, making it vital to pause and assess when to disengage from people, environments, or behaviors that could negatively impact your health or well-being. As always decisions should be made in reference to your inner authority only.

**Practical Guidance for This Venus Cycle:**

- **Tune into your body's signals:** Begin recognizing even the subtler cues your body provides regarding your health and safety. These signals may take time or reflection to fully understand, but they are worth listening to.
- **Be aware of your environment:** Surround yourself with positive, supportive people and settings that encourage well-being. Your undefined nature makes you sensitive to the health and fears of others, so choose environments that uplift rather than drain you.
- **Learn from past experiences:** Use your history of health and intuitive decisions to guide your future choices. Over time, you can develop a deeper understanding of what works for you.
- **Avoid rushing into health trends:** Your journey to well-being is experiential, not predetermined. Take your time exploring what resonates with you, and don't feel pressured to conform to external advice or expectations.
- **Seek advice when needed:** Deliberating over health-related decisions and consulting trusted sources can help you make clearer, more informed choices.

This cycle presents an opportunity to deepen your relationship with your body and intuition. Your undefined Splenic Center invites you to take a more reflective, exploratory approach to health and well-being. By embracing the lessons of your experiences, you can navigate your awareness and survival with greater clarity and confidence. Trust in your unique process and allow your wisdom to unfold naturally.

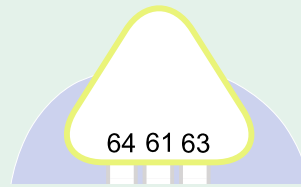

Venus Cycle Center Theme: Undefined Head Center

Reflecting on Mental Pressure, Inspiration, and Clarity

In this Venus Cycle, your Head Center remains undefined, which means your relationship with inspiration, questions, and mental pressures will continue to be shaped by external influences. The Head Center is the source of mental stimulation, big questions, and the drive to seek answers. With it undefined, your experience of inspiration is fluid and adaptive, allowing you to explore a wide range of inspirational perspectives.

Having an undefined Head Center means that your mind is not designed to generate consistent mental pressure or inspiration from within. Instead, you are uniquely receptive to the questions and ideas present in your environment. This openness allows you to sample and explore a variety of mental perspectives, which can lead to profound insights and wisdom over time. However, it also comes with challenges, as you may find yourself absorbing and amplifying external mental pressures, often chasing questions or concerns that aren't truly relevant to your journey.

Because of this sensitivity, you may feel a constant drive to "figure things out" or resolve questions that don't actually require answers. The pressure to find clarity or certainty can feel overwhelming, particularly if you are unaware of how much of this mental energy is coming from outside yourself. Recognizing that not all thoughts or questions are yours to solve is key to navigating this openness in a healthy way.

Your inspiration tends to arise in waves, influenced by the people and environments around you. While this might feel inconsistent compared to those with a defined Head Center, it also allows you to experience periods of mental quiet and peace when you're away from external stimuli. This natural ebb and flow can be a gift, providing you with clarity and focus when you step back from the mental noise of the world.

A crucial part of mastering your undefined Head Center is learning to set boundaries around mental stimulation. You may be particularly prone to distraction, especially in environments filled with external input like media, news, or social platforms. These sources can amplify mental pressure and scatter your focus, pulling you into cycles of overthinking or chasing thoughts that don't serve your growth. By consciously limiting exposure to unnecessary mental input and creating space for stillness, you can find greater clarity and discernment in your thinking.

**Practical Guidance for This Venus Cycle:**

- **Recognize external pressures:** Notice when you're taking on questions or mental pressures that aren't truly yours. Give yourself permission to release thoughts that don't serve your growth.
- **Embrace mental fluidity:** Allow your inspiration to ebb and flow naturally. Trust that periods of mental quiet are just as valuable as moments of insight.
- **Set boundaries with distractions:** Limit exposure to overstimulating environments like news, social media, or excessive digital content. Create quiet spaces where you can focus and reflect.
- **Let go of the need to "figure it all out":** Not every question or problem requires an answer. Trust that clarity will come when it's needed.
- **Focus on what matters:** Direct your mental energy toward questions and ideas that genuinely resonate with your path, rather than scattering it on irrelevant concerns.
- **Find peace in stillness:** Incorporate practices like meditation or quiet reflection to help you manage mental pressure and maintain clarity.

In this cycle, your undefined Head Center invites you to embrace the freedom of mental flexibility and to release the pressure to follow every mental inspiration that arises. By discerning which thoughts and inspirations are truly meaningful, you can focus your energy on what matters most while maintaining clarity and peace of mind. Your undefined Head Center offers you the potential for deep wisdom, helping you see the big picture and navigate life's mental pressures with grace and insight.



Conclusion

So, there you have it! Your Venus Return Cycle explained in great detail. It's truly exciting to see everything mapped out and to know how these themes will unfold during this period of your life.

Throughout this report, you've been reminded that just because a theme is imprinted by the Venus Return program, it doesn't mean you are obligated to engage with it. Your Inner Authority exists for a reason—it is there to guide you in choosing what is correct for you to interact with.

If you continue to rely on your mind for decisions, then it becomes "fait accompli." The mind will see everything as important and insist on engaging with it all. This is precisely what the conditioning program desires: for you to follow the mind so it can control your decisions. When this happens, you risk being herded along, living a life that isn't truly yours—just like so many others.

We wish you a wonderful Venus Return and hope you find the strength and purpose to embody who you truly are. May this year be a profound journey of alignment and self-discovery!

[Foundation Talking Chart](#)



[Foundation Report](#)





GENETIC MATRIX



WWW.GENETICMATRIX.COM



GENETICMATRIX



GENETIC_MATRIX

Industry-leading Human Design & Astro HID software since 2008.

Specialising in Human Design Talking Charts & Reports.

Access over 500 chart views at Pro level.